

# FALL PROTECTION

## Product Catalog



# HIGHER STANDARDS

# IN FALL PROTECTION

# HIGHER STANDARDS



Reliance Fall Protection began operations in the year 2000 by patenting a revolutionary new technology for the design of horizontal lifeline systems that allowed the reduction of fall height requirements without increased end-loadings. These TunedCable™ horizontal lifelines are one of those “it can’t be done” innovations that suddenly appear simple once the science behind them is understood. The lifelines were followed by unique anchorages, the concrete embed system with remote connection, beam clamps and trolleys, and other engineered products.

Reliance has now turned attention to harnesses and lanyards, with the patented “TattleTale”™ webbing, the “FatPack”™ two-in-one shock absorbing lanyard, and especially the Steelhead® tieback hook. The SteelHead® is another “it can’t be done” product, a standard-layout true double-action locking snap hook that makes it possible for workers to safely tie back into their own lanyards. And with these additions Reliance has assembled a complete range of cutting-edge fall protection products that represent the very Highest Standards in Personal Fall Protection Equipment.

Reliance Fall Protection is quickly becoming the go-to organization for custom and unique industry solutions. With a full in house engineering staff, product development department, testing facility and vertically integrated manufacturing process, difficult fall protection solutions can go from concept to application in a single streamlined process.

For more information about Reliance Fall Protection products, visit us at [www.relsafe.com](http://www.relsafe.com) or call us at 1.888.362.2826.

Reliance Fall Protection is proud to offer premier fabrication and production facilities in both Arvada, Colorado and Deer Park, Texas. Incorporating the latest technology for our industry allows Reliance to maintain our commitment to “Higher Standards.” Lifeline production facilities utilize, mig welding processes, industrial CNC controlled milling machines, plate shearing and breaking, as well as plasma cutting and water jet processes. Within our textile processing plant, CNC controlled sewing machines, CNC cutting and marking machines, as well as automated grommet machines assist in the quality and dependability of our products.



Reliance is dedicated to providing higher standards through our engineering department as well as research and development. Autocad™, SolidWorks™, and Autodesk Inventor™ are just a few of the software programs incorporated into the engineering and design process. The Reliance Industries manufacturing team offers over 50 years of experience in the fall protection industry. Our team is committed to offering the safest work environment possible. For the “at risk” worker as well as within our own family, engineering a safe workplace is our responsibility and future.

## EXCELLENCE IN MANUFACTURING

# PRODUCT TESTING



The Reliance Testing Laboratory is ISO 17025 accredited and is utilized to perform Qualification and Verification Testing as required by ANSI Z359.7-2011. The Lab features ANSI compliant, certified test towers as well as all of the certified equipment required to perform dynamic and static tests necessary to demonstrate compliance with the applicable ANSI standards for fall protection.

Reliance Testing Laboratory operates equipment that can perform tensile testing up to 20,000 lbs (88.8kN), and drop towers that capture data via Daisylab™ software which translates the information to spreadsheets and graphs. Through the analysis produced, Reliance is able to uncover opportunities to improve product performance and service life.

With state of the art equipment and processes, Reliance is able to provide users with test results from real tests verifying your equipment's performance and conformity. Whether we are verifying quality and conformity on our current selection of products or developing and qualifying new solutions, Reliance truly raises the bar by testing products to meet existing the standards and then going a step further to ensure they meet our requirements for a higher standard in fall protection.

Training your employees in fall protection is a great way to increase awareness about the hazards of falling from heights. At Reliance, we offer several training courses that help users identify hazards, understand the risks, develop inspection procedures and programs, and implement procedures to mitigate the hazards associated with fall protection. Knowledge is truly the key to providing a safe work place for your employees. Reliance offers a monthly training program for Competent Inspectors of Fall Protection Equipment, as well as quarterly courses for Fall Protection Competent Persons.



## Competent Inspector (Monthly)

The Competent Inspector's course builds upon a student's practical knowledge of fall protection through the discussions of in-house testing and literature review; UV and chemical exposure to synthetic strapping and is designed to increase personal skill level through a variety of hands-on inspection exercises.

## Competent Person (Quarterly)

The Competent Person training is an intensive program that develops a strong overall knowledge of how to use, select and install conventional and non-conventional fall protection equipment. In class lectures including slides and video, hands on scenarios applying practical workplace situations.

*Please contact us for more detailed information on Fall Protection Training from Reliance.*

# TRAINING CENTER

# TABLE OF CONTENTS

<b>FULL BODY HARNESSES</b>	<b>5-18</b>
<b>SELF RETRACTING LANYARDS</b>	<b>19-28</b>
<b>ENERGY ABSORBING LANYARDS</b>	<b>29-32</b>
<b>ANCHORAGE CONNECTORS</b>	<b>33-38</b>
<b>CONFINED SPACE</b>	<b>39-42</b>
<b>HORIZONTAL &amp; VERTICAL SYSTEMS</b>	<b>43-55</b>

# FULL BODY HARNESSES

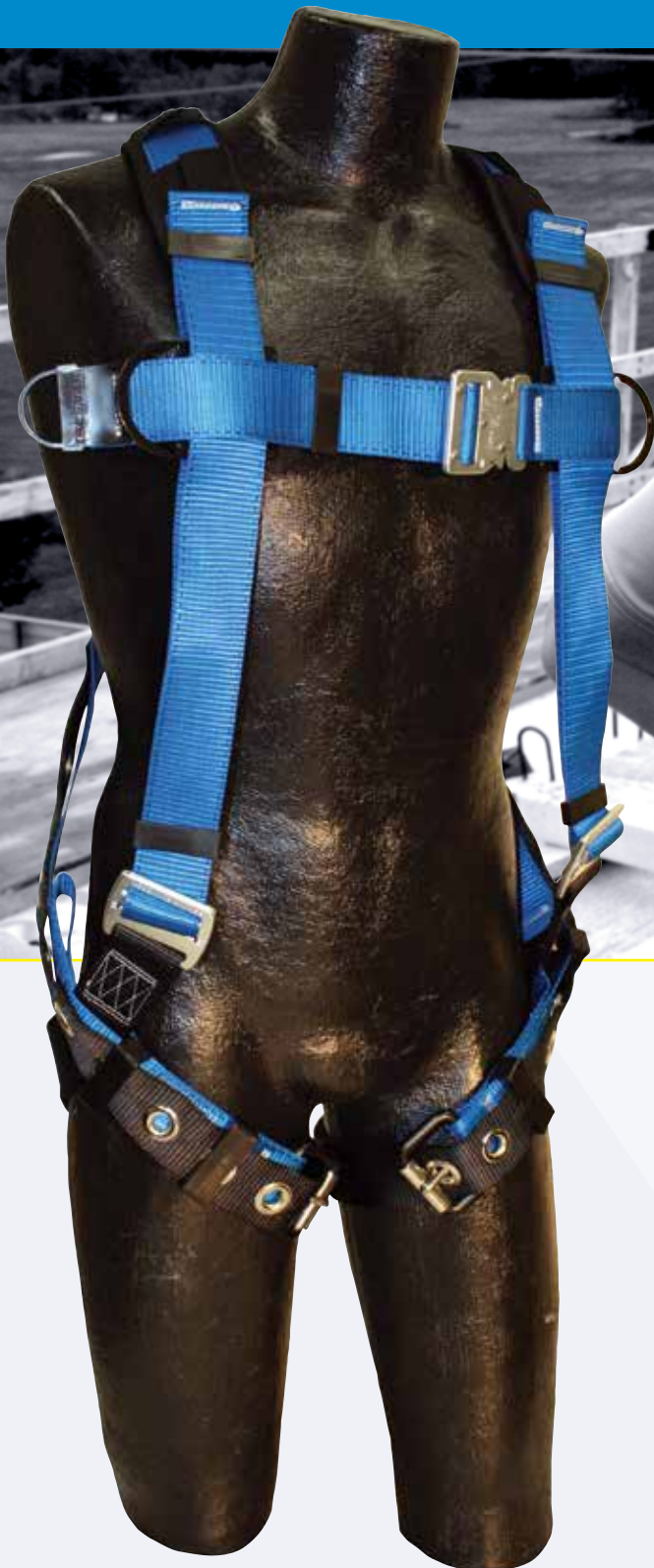

THE **OPTIMUM** SOLUTION  
FOR **FALL PROTECTION**



# Reliance Ironman™ Lite Series Harnesses

Each Ironman™ Lite Full Body Harness is inspectable with TattleTale® webbing that has an interior ply of contrasting black “strength” yarns that increase webbing strength to 7000 lbs (31kN) and instantly reveals cuts or abrasion, has built-in impact load indicators, and bar-coded individual serial numbers for traceability.

Completely comfortable with removable back support/tool belt and shoulder padding, Reliance Quick-Adjust™ torso adjustment buckles, a Quick-Connect chest buckle, and “floating” thigh stitching that reduces binding. Improved geometry places buckles on the front of the thigh, and angled stitching for “tailored” sub-pelvic fit, plus an extra large back pad that eliminates dangerous ‘D-ring droop’.

The Ironman™ Lite Series is extremely durable with no elastic webbing, heat-set labels that won’t come off, and extra heavy-duty corrosion and abrasion resistant leg grommets. Includes extra thick woven (not sewn) seat webbing for added durability and premium anodized aluminum alloy hardware for high strength and reduced weight.

## IRONMAN™ LITE FEATURES



Aluminum Torso Adjustors



Stand-Up Aluminum Dorsal D-Ring



Aluminum Positioning D-Rings (802000)



Aluminum Positioning D-Rings (812000)



Integrated Back Belt (812000)



Dual Lanyard Keepers



Back Belt Position Adjustors



Slim Profile Quick Connect Chest Buckle



Anodized Aluminum Tongue Buckles



Silver Aluminum Grommets



### IDEAL FOR USE WITH THE RELIANCE STOPLITE II®

*Ironman™ Lite is a new grade of harness designed for the power-user, combining premium features with the classic utility of Reliance Full Body Harnesses. The aluminum alloy hardware provides the strength of steel without the weight, ensuring greater comfort and increased compliance and productivity.*

*Ironman™ Lite is constructed using superior materials without embellishment, in an effort to give you what you need to get the job done : safely, on-time, and on budget!*

# Reliance Ironman™ Lite Series

Designed for Hard Work - Now 10% - 30% Lighter

## Ironman™ Lite 800000-A

- Vest Style
- Polyester Webbing
- Tongue Buckle Leg Straps
- Single Dorsal D-Ring for Fall Arrest
- Universal Fit (Medium - Large)



## Ironman™ Lite 802000-A

- Vest Style
- Polyester Webbing
- Tongue Buckle Leg Straps
- Single Dorsal D-Ring for Fall Arrest
- Hip D-Rings for Work Positioning
- Universal Fit (Medium - Large)

## Ironman™ Lite 812000-A

- Construction Style
- Polyester Webbing
- Tongue Buckle Leg Straps
- Integrated Adjustable/Removable Waist Pad and Belt
- Single Dorsal D-Ring for Fall Arrest
- Side D-Rings for Work Positioning
- Universal Fit (Medium - Large)



## Ironman™ Lite 825000-A

- Construction style
- Polyester webbing
- Tongue buckle leg straps
- D-rings for all arrest, positioning and climbing
- Includes detachable seat sling for suspension work and prolonged work-positioning
- Universal Fit (Medium - Large)

# D-Ring. Extended.

Ironman™ Lite harnesses with part numbers ending in 'AC' feature a permanently attached 18" dorsal D-ring extender. This feature provides the user with an easier method of connection to a deceleration device. In addition, the extender can be placed over the user's shoulder and adhered to the shoulder strap with hook-and-loop material when not in use.

*(Please Note : The additional length of a D-ring extender must be taken into consideration when calculating free-fall distance).*



## Reliance Ironman™ Lite Full Body Harnesses

Part Number	Style	D-Rings	Chest Buckle	Leg Buckle	Web Material	Size/Other
800000-A	Vest	Back	Quick-Connect	Tongue Buckle	Polyester	Universal Fit
801000-A	Vest	Back, Chest	Quick-Connect	Tongue Buckle	Polyester	Universal Fit
802000-A	Vest	Back, Hip	Quick-Connect	Tongue Buckle	Polyester	Universal Fit
803000-A	Vest	Back, Chest, Hip	Quick-Connect	Tongue Buckle	Polyester	Universal Fit
804000-A	Vest	Back, Shoulder	Quick-Connect	Tongue Buckle	Polyester	Universal Fit
809000-A	Derrick	Back, Side	Quick-Connect	Tongue Buckle	Polyester	Universal Fit
812000-A	Construction	Back, Side	Quick-Connect	Tongue Buckle	Polyester	Universal Fit
812040-A	Construction	Back, Side	Quick-Connect	Quick-Connect	Polyester	Universal Fit
813000-A	Construction	Back, Chest, Side	Quick-Connect	Tongue Buckle	Polyester	Universal Fit
815000-A	Construction	Back, Side, Suspension	Quick-Connect	Tongue Buckle	Polyester	Universal Fit / Suspension Seat
816000-A	Derrick	Back, Chest, Hip, Shoulder	Quick-Connect	Tongue Buckle	Polyester	Universal Fit
819000-A	Construction	Back, Hip	Quick-Connect	Tongue Buckle	Polyester	Universal Fit
825000-A	Construction	Back, Chest, Hip, Suspension	Quick-Connect	Tongue Buckle	Polyester	Universal Fit / Suspension Seat
800000-AC	Vest	Back	Quick-Connect	Tongue Buckle	Polyester	Universal Fit
802000-AC	Vest	Back, Hip	Quick-Connect	Tongue Buckle	Polyester	Universal Fit
812000-AC	Construction	Back, Side	Quick-Connect	Tongue Buckle	Polyester	Universal Fit / Sewn-In Belt

*\*Note: Harnesses sized as follows: 8XX1XX = Small, 8XX4XX = X-Large, 8XX5XX = XXL, 8XX6XX = Big Boy  
Harnesses with part numbers ending in 'AC' feature a permanently attached 18" dorsal D-ring extender.*



# Reliance 'A' Series Harnesses

**Complete Inspectability** Harnesses from Reliance feature Tattletale® webbing, which has an interior ply of contrasting bright red “strength” yarns that increase webbing strength to 7000 lbs (31kN) and instantly reveal cuts or abrasions. Harnesses also feature built-in impact load indicators for ease of visual inspection. Each harness is bar-coded with individual serial numbers for traceability, and each features an indelible serial number stamped into the back plaque.

**Comfort Redefined** The “floating” thigh stitching used in harness construction reduces binding and pinching on the wearer. Improved geometry brings buckles to the *front* of the thigh as opposed to the hip. Angled stitching provides more of a “tailored” sub-pelvic fit, and the extra large back pad eliminates dangerous “D-ring droop”.

**Durability Ensured** Reliance 'A' Series harnesses use NO elastic webbing, which translates to a longer life. Heat-set labels won't come off, meaning inspections are easier and harnesses can stay in service longer. Corrosion resistant grommets and extra-thick woven (not sewn) seat webbing adds to overall durability.

## 'A' SERIES FEATURES



**Extra-Thick Woven Seat Webbing**



**Improved Geometry**



**Extra-Large Back Pad**



**Corrosion Resistant Grommets**



**Built-In Impact Load Indicators**



**Lanyard Keepers on Chest Strap**

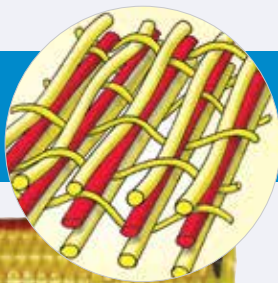

## What is Tattletale® Web?

Tattletale® web is inspectable web. All load-bearing straps in Reliance harnesses and lanyards have a red inner core (or a yellow core in black webbing) which becomes exposed when the web becomes damaged by cuts or abrasion. Red that shows through is not a “red light” signalling the user to stop using the equipment, it simply “tells” the user that the equipment needs closer inspection, and where to look. The webbing helps again by giving the Competent Person (the expert) the information needed to judge how deep the cuts or abrasions are, so the seriousness of the issue can be determined. Call Reliance at 800.330.9240 for complete inspection procedures.





### 'A' Series Positioning 802000

- Vest style
- Back & side positioning D-rings
- Universal fit (Medium - Large)
- Tongue buckle thigh straps
- Polyester webbing

### 'A' Series Standard 800000

- Vest style
- Back D-ring
- Universal fit (Medium - Large)
- Tongue buckle thigh straps
- Polyester webbing



### 'A' Series Reflective 800006

- Back D-ring
- Universal fit (Medium - Large)
- Tongue buckle thigh straps
- Reflective tape front & back

### 'A' Series Climbing 803000

- Vest style
- Back, side positioning, & chest D-ring for climbing
- Universal fit (Medium - Large)
- Tongue buckle thigh straps
- Polyester webbing





### 'A' Series Climbing 801000

- Vest style
- Back & chest D-ring for climbing
- Universal fit (Medium - Large)
- Tongue buckle thigh straps
- Polyester webbing



885016 Belt - sold separately



885021 Belt - sold separately



885050 Seat - sold separately

### 'A' Series Derrick 809000

- Vest style - derrick
- Back, side positioning & climbing D-rings
- Universal fit (Medium - Large)
- Tongue buckle thigh straps
- Polyester webbing
- 18" (45cm) D-ring extender
- Belly board & saddle seat attachment buckles



### 'A' Series Retrieval 804000

- Vest style
- Back, shoulder, D-rings
- Universal fit (Medium - Large)
- Tongue buckle thigh straps
- Polyester webbing

### 'A' Series Retrieval 806000

- Vest style
- Back, side positioning, shoulder, & chest D-ring for climbing
- Universal fit (Medium - Large)
- Tongue buckle thigh straps
- Polyester webbing





### 'A' Series Dielectric 800002

- Vest style
- Universal fit (Medium - Large)
- Dielectric back D-ring
- Tongue buckle thigh straps
- Polyester webbing
- No exposed metal
- Sliding hardware cover



### 'A' Series Polyurethane 800005

- Vest style
- Back D-ring
- Universal fit (Medium - Large)
- Tongue buckle thigh straps
- .05" (1.2mm) Polyurethane coated webbing



### 'A' Series Kevlar®/Nomex® 800052

- Vest style
- Back D-ring
- Universal fit (Medium - Large)
- Pass-through mating buckles
- Kevlar®/Nomex® webbing



### 'A' Series Kevlar®/Nomex® Dielectric 800051

- Vest style
- Dielectric back D-ring
- Universal fit (Medium - Large)
- Pass-through mating buckles
- PVC coated hardware w/ sliding covers
- Kevlar®/Nomex® webbing
- ASTM 877 compliant



### 'A' Series Polyurethane 802005

- Vest style
- Back & side positioning D-rings
- Universal fit (Medium - Large)
- Tongue buckle thigh straps
- .05" (1.2mm) Polyurethane coated webbing

### 'A' Series Polyurethane 802055

- Vest style
- Back D-ring
- Universal fit (Medium - Large)
- Pass-through mating buckles
- .05" (1.2mm) Polyurethane coated webbing



### 'A' Series Reflective 802006

- Vest style
- Back D-ring
- Universal fit (Medium - Large)
- Tongue buckle thigh straps
- Polyester webbing
- Reflective tape front & back

### 'A' Series Pullover 841000

- Pullover style
- Back, front D-rings
- Side positioning O-rings
- Universal fit (Medium - Large)
- Tongue buckle thigh straps
- Polyester webbing



Reliance 'A' Series Full Body Harnesses

Part Number	Style	D-Rings	Connectors	Web Material	Size/Other
800000	Vest	Back	Tongue Buckle	Polyester Web	Universal Fit
800002	Vest	Dielectric Back	Tongue Buckle	Polyester Web	No metal above waist/ Sliding Covers
800005	Vest	Back	Tongue Buckle	Polyurethane Coated	Universal Fit
800006	Vest	Back	Tongue Buckle	Polyurethane Coated	Reflective Tape Front/Back
800051	Vest	Dielectric Back	Pass-Through	Kevlar®/Nomex®	Coated Hardware with Sliding Covers
800052	Vest	Back	Pass-Through	Kevlar®/Nomex®	Universal Fit
801000	Vest	Back, Chest	Tongue Buckle	Polyester	Universal Fit
802000	Vest	Back, Side	Tongue Buckle	Polyester	Universal Fit
802005	Vest	Back, Side	Tongue Buckle	Polyurethane Coated	Universal Fit
802006	Vest	Back, Side	Tongue Buckle	Polyester	Reflective Tape Front/Back
802055	Vest	Back	Pass-Thru	Polyurethane Coated	Universal Fit
803000	Vest	Back, Side, Chest	Tongue Buckle	Polyester	Universal Fit
804000	Vest	Back, Shoulder	Tongue Buckle	Polyester	Universal Fit
806000	Vest	Back, Side, Shoulder, Chest	Tongue Buckle	Polyester	Universal Fit
809000	Vest	Back, Side, Climbing	Tongue Buckle	Polyester	18" (45cm) D-Ring Extender, Belly Board & Saddle Seat Attachments
841000	Pullover	Back, Front, Side O's	Tongue Buckle	Polyester	Universal Fit
802015	Vest	Back, Side	Tongue Buckle	Polyester	Comfort Series

\* Please Note : Harnesses sized as follows : 8XX1XX = Small, 8XX4XX = X-Large, 8XX5XX = XXL, 8XX6XX = Big Boy

## Harness Buckle Types

All Reliance 'A' Series and Ironman™ Series full body harnesses utilize one of two types of fasteners to secure the lower leg portion of the harness (all chest straps are secured using pass-thru buckles)



Tongue buckle and grommet fasteners are corrosion resistant to ensure smooth, consistent operation. Grommets are inserted through an opening in the web as opposed to a punched hole to maintain webbing integrity. Consistent spacing ensures a custom fit regardless of user size. Harness sizing adjustment is easy, especially when wearing gloves.

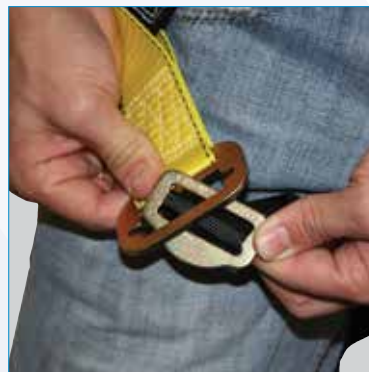

Pass-Thru buckles are zinc-coated and smooth for a precise fit. Placement of the web through the buckle provides for a higher degree of custom adjustment than grommet and tongue buckle fasteners, and use of Pass-Thru buckles reduce the overall weight of the harness. Pass-Thru buckles are standard chest strap fasteners on all Reliance harnesses.

Tongue Buckle Fasteners

Pass-Thru Fasteners

# Reliance Ironman™ Series Construction Harnesses

The Reliance Ironman™ series with added padding and tool/accessory belts is ideal for use in heavy construction, maintenance, and in harsh environments.

**Complete Inspectability** Harnesses from Reliance feature Tattletale® webbing, which has an interior ply of contrasting bright red “strength” yarns that increase webbing strength to 7000 lbs (31kN) and instantly reveal cuts or abrasions. Harnesses also feature built-in impact load indicators for ease of visual inspection. Each harness is bar-coded with individual serial numbers for traceability, and each features an indelible serial number stamped into the back plaque.

**All-Day Comfort** Ironman™ Series harnesses are built for comfort, featuring both a removable padded back support/tool belt and shoulder padding. Reliance Quick Adjust™ torso adjustment buckles make fine-tuning a harness fit quick and easy. Slotted positive engaging chest buckles ensure ease of connection, and eliminate the possibility of a missed closure point. The “Floating” thigh stitching used in harness construction reduces binding and pinching on the wearer. Improved geometry brings buckles to the *front* of the thigh as opposed to the hip. Angled stitching provides more of a “tailored” sub-pelvic fit, and the extra large back pad eliminates dangerous “D-ring droop”.

**Durability Ensured** Reliance ‘A’ Series harnesses use NO elastic webbing, which translates to a longer life. Heat-set labels won’t come off, meaning inspections are easier and harnesses can stay in service longer. Extra heavy-duty corrosion resistant grommets and extra-thick woven (not sewn) seat webbing adds to overall durability.

## IRONMAN™ SERIES FEATURES



**Integrated Belt & Shoulder Padding**



**Improved Geometry**



**Heavy Duty Corrosion Resistant Grommets**



**Built-In Impact Load Indicators**



**Quick-Adjust™ Torso Buckles**



**Designed for HARD WORK**



### Ironman™ Series Construction 810000

- Ironman™ Harness
- Vest style
- Integrated work belt
- Back D-ring
- Universal fit (Medium - Large)
- Tongue buckle thigh straps
- Polyester webbing

### Ironman™ Series Climbing 811000

- Ironman™ Harness
- Vest style
- Integrated work belt
- Back D-ring, chest D-ring for climbing
- Universal fit (Medium - Large)
- Tongue buckle thigh straps
- Polyester webbing



### Ironman™ Series Positioning 812000

- Ironman™ Harness
- Vest style
- Integrated work belt
- Back & side positioning D-rings
- Universal fit (Medium - Large)
- Tongue buckle thigh straps
- Polyester webbing

### Ironman™ Series Climbing/Positioning 813000

- Ironman™ Harness
- Vest style
- Integrated work belt
- Back & side positioning D-rings, chest D-ring for climbing
- Universal fit (Medium - Large)
- Tongue buckle thigh straps
- Polyester webbing







### Ironman™ Series Suspension 815000

- Ironman™ Harness
- Vest style
- Integrated work belt
- Back & side positioning D-rings
- Integrated suspension seat
- Universal fit (Medium - Large)
- Tongue buckle thigh straps
- Polyester webbing

### Ironman™ Series Retrieval 814000

- Ironman™ harness
- Vest style
- Integrated work belt
- Back & shoulder D-rings
- Universal fit (Medium - Large)
- Tongue buckle thigh straps
- Polyester webbing



### Ironman™ Series Retrieval/Climbing 816000

- Ironman™ harness
- Vest style
- Integrated work belt
- Back, side positioning, front, & shoulder D-rings
- Universal fit (Medium - Large)
- Tongue buckle thigh straps
- Polyester webbing

885050 Seat included - may be purchased separately



### Ironman™ Series Suspension/Tower 825000

- Ironman™ harness
- Vest style
- Integrated work belt
- Includes 'X' comfort pad
- Back, chest, & side positioning D-rings
- Detachable padded aluminium suspension seat
- Universal fit (Medium - Large)
- Tongue buckle thigh straps
- Polyester webbing



Reliance Ironman™ Full Body Harnesses

Part Number	Style	D-Rings	Connectors	Web Material	Work Belt	Size/Other
810000	Vest	Back	Tongue Buckle	Polyester	Yes	Universal Fit
811000	Vest	Back, Chest	Tongue Buckle	Polyester	Yes	Universal Fit
812000	Vest	Back, Side	Tongue Buckle	Polyester	Yes	Universal Fit
813000	Vest	Back, Chest, Side	Tongue Buckle	Polyester	Yes	Universal Fit
814000	Vest	Back, Shoulder	Tongue Buckle	Polyester	Yes	Universal Fit
815000	Vest	Back, Side	Tongue Buckle	Polyester	Yes	Integrated Suspension Seat
816000	Vest	Back, Side, Front, Shoulder	Tongue Buckle	Polyester	Yes	Universal Fit
825000	Vest	Back, Side, Chest	Tongue Buckle	Polyester	Yes	Detachable Saddle Seat, 'X' Pad
812105	Vest	Back, Side	Tongue Buckle	Polyester	Yes	Comfort Series

\*Please Note : Harnesses sized as follows : 8XX1XX = Small, 8XX4XX = X-Large, 8XX5XX = XXL, 8XX6XX = Big Boy

# Comfort Series Harnesses

Based on the standard "A"™ Series and Ironman™ harnesses, the Comfort Series harnesses come with the 880082 "X" Comfort Pad and the 880092 Thigh Comfort Pads pre-installed. Pads are made from a durable nylon outer fabric, a soft, breathable foam center and a moisture wicking lining to provide all day comfort. Comfort Pads are designed to distribute the harness contact points over a larger surfaced area, and reduce fatigue throughout the day - even when used with heavy tool belts. Pads are removable, machine washable, and can be ordered separately and installed on most any harness.

## 'A' Comfort Series 802015

- Pre-Installed back & thigh padding
- Vest style
- Back & side positioning D-rings
- Universal fit (Medium - Large)
- Tongue buckle thigh straps
- Polyester webbing



## Ironman™ Comfort Series 812015

- Pre-Installed back & thigh padding
- Vest style
- Integrated work belt
- Back & side positioning D-rings
- Universal fit (Medium - Large)
- Tongue buckle thigh straps
- Polyester webbing



- "X" pad assists in harness donning by keeping shoulder straps separated and preventing entanglement
- Thigh pads provide comfort in the event of extended after-fall suspension
- Moisture Wicking Lining
- Washable Aearated Foam
- Field Installable
- 'X' Padding Available Separately
- Leg Padding Available Separately

# SELF RETRACTING LANYARDS



**UNPRECEDENTED PROTECTION**  
**UNRIVALED PERFORMANCE**



# Reliance EnviroShield®. Built to Last.

## Exceeding ALL Standard & Regulatory Requirements

100% Stainless Steel & Military-Grade Anodized Aluminum Construction with NO Structural Castings



1. Durable Stainless Steel Anchorage Connection
2. Stainless Steel Bulkhead Plates form the Front & Rear Face and separate the three internal chambers
3. Sealed Power Spring & Clutch Chambers achieve IP69K Rating, surpassing the less stringent IP68 requirements
4. Features the Reliance Fail-Safe Locking Mechanism for positive locking performance EVERY time. The ULTIMATE in Anti-Ratcheting design.
5. Durable Extruded Aluminum Housing eliminates the porosity common in castings and greatly reduces machining costs
6. Built-in Carry Handle with Comfort Grips
7. Stainless Steel Formed Drum Assembly for increased strength & durability
8. Billet Aluminum Hub protects Sealed Clutch Chamber
9. Sacrificial Zinc Anodes eliminate galvanic corrosion
10. Ergonomic Cable Grip
11. Stainless Steel Load-Indicating Carabiner & Stainless Steel Wire Rope STANDARD (not optional)

**Self-Retracting Lanyards** are increasingly the preferred devices for making fall arrest connections. For years the prevailing trend has been to make these devices lighter and cheaper. At Reliance, we have observed and listened to our customers, and **our decision has been to make them better.**

**The EnviroShield® design** began with a white piece of paper and was engineered to provide **unmatched protection in extreme environments.** We began by selecting the best materials that would yield **the most durable, long lasting product available.** We then selected **the most effective and efficient manufacturing methods** to ensure that we could make **the highest level of protection AFFORDABLE.**

**The end-result** is a product that **performs better and lasts longer** with **lower acquisition costs** and **lower long-term cost of ownership.**

**Specifically designed for applications such as:**

- Oil & Gas
- Marine Environments
- Offshore & Wind Energy
- Utilities
- Waste Water Treatment
- Food Processing Operations
- Mining Operations
- Any environment where severe, prolonged exposure to the elements can result in performance issues with mechanical equipment

**The perfect solution for:**

- Fixed ladders
- Platform Access
- Vertical Ingress & Egress
- Rigid Fall Arrest Systems

# Ingress Protection

Under the International Electrotechnical Commission **IEC 60529 standard**, Ingress protection is evaluated to determine the degree of protection provided against the intrusion of dust and water into mechanical casings and electrical enclosures. To achieve a **Rating of IP69K**, which is the highest possible rating, an assembly must be dust-tight, allowing absolutely no ingress of dust, and must also prevent the intrusion of powerful, high-temperature water jets.

**Reliance EnviroShield® not only meets these requirements, but also withstands an unprecedented 1,000 hour salt-spray.**

Specifications	
*Patents Pending	
<b>Industry Standards</b>	
<ul style="list-style-type: none"> <li>• Meets or exceeds the requirements of Title 29 CFR, Subparts I &amp; M</li> <li>• ANSI/ASSE Z359.14, Class B</li> <li>• IEC 60529 - IP69K</li> </ul>	
<b>Performance Specifications</b>	
Maximum Arrest Force	≤ 1,800 lbs
Average Arrest Force	≤ 900 lbs
Arrest Distance	< 36"
Capacity	310 lbs
<b>Material Specifications</b>	
Housing	Anodized Aluminum
Bulkhead Plates	Stainless Steel
Drum	Stainless Steel
Constituent Line	Wire Rope, Stainless, 3/16", 7x19
Attachment-End Connector	Load-Indicating, Stainless Steel
Locking Mechanism	Mechanically Activated
Energy Management System	Rotary Brake

Reliance EnviroShield® Self Retracting Lanyards			
Part Number	Working Length	Cable Type	Connector Type
4102050-1	50'	Stainless Steel	Stainless, Load-Indicating
4102085-1	85'	Stainless Steel	Stainless, Load-Indicating
4102100-1	100'	Stainless Steel	Stainless, Load-Indicating
4102130-1	130'	Stainless Steel	Stainless, Load-Indicating
4102175-1	175'	Stainless Steel	Stainless, Load-Indicating

# SkyLoc™ II SERIES

## Redesigned - Inside AND Out

The SkyLoc™ name has always been synonymous with durable, reliable performance. The new SkyLoc™ II Series is built on that reputation, but we've added features that make this series safer, and easier to use than ever before.

Our new lightweight, fiberglass reinforced, stackable nylon housings include things like a big carry handle opposite a flat surface, making the units easier to transport and store. A swivel connection on top combined with a swivelling snap hook means no twisting on your anchorage. And a rubberized, form-fitted cable grip makes feeding out cable a snap.



\*Patents Pending

### SkyLoc™ II Series

#### Additional Features:

- Fiberglass reinforced nylon housing
- Load-bearing steel frame
- Over-sized steel anchor swivel
- Patented, non-centrifugal Fail-Safe locking mechanism
- Lightweight and incredibly rugged
- Exceeds the Class A requirements of ANSI Z359.14
- Exceeds the requirements of OSHA 1910 and 1926

Reliance SkyLoc™ II Self Retracting Lanyards

Part Number	Working Length	Cable Type	Housing Material	Connector
4000020-1	20'	Galvanized	Fiberglass Reinforced Nylon	3007 Double Locking w/ Swivel
4000030-1	30'	Galvanized	Fiberglass Reinforced Nylon	3007 Double Locking w/ Swivel
4000050-1	50'	Galvanized	Fiberglass Reinforced Nylon	3007 Double Locking w/ Swivel
4000065-1	65'	Galvanized	Fiberglass Reinforced Nylon	3007 Double Locking w/ Swivel
4000080-1	80'	Galvanized	Fiberglass Reinforced Nylon	3007 Double Locking w/ Swivel
4000100-1	100'	Galvanized	Fiberglass Reinforced Nylon	3007 Double Locking w/ Swivel

# SkyLoc™ II SERIES

## Specialty Range

### SkyLoc™ II : Harsh Environment Series

Functionally and visually identical to the original SkyLoc™ II, but all of the metallic components are constructed from durable stainless steel - making them a perfect solution for harsh environments or prolonged exposure to the elements.

### Harsh Environment Series

#### Additional Features:

- Fiberglass reinforced nylon housing
- Load-bearing Stainless Steel frame
- High-efficiency rotary brake
- 3/16" 7x19 stainless steel wire rope
- Stainless steel load-indicating swivel carabiner
- Exceeds the Class A requirements of ANSI Z359.14



Reliance SkyLoc™ II Harsh Environment Series				
Part Number	Working Length	Cable Type	Housing Material	Connector
4302020-1	20'	3/16", 7X19 Stainless Steel	Fiberglass Reinforced Nylon	Stainless Load-Indicating Swivel Carabiner
4302030-1	30'	3/16", 7X19 Stainless Steel	Fiberglass Reinforced Nylon	Stainless Load-Indicating Swivel Carabiner
4302050-1	50'	3/16", 7X19 Stainless Steel	Fiberglass Reinforced Nylon	Stainless Load-Indicating Swivel Carabiner
4302080-1	80'	3/16", 7X19 Stainless Steel	Fiberglass Reinforced Nylon	Stainless Load-Indicating Swivel Carabiner
4302100-1	100'	3/16", 7X19 Stainless Steel	Fiberglass Reinforced Nylon	Stainless Load-Indicating Swivel Carabiner

### SkyLoc™ II : Aviation Series

The SkyLoc™ II Aviation Series utilizes a high-strength braided DYNEEMA® rope as opposed to wire rope, which greatly reduces the risk of damage to adjacent structures such as fuselage skins, leading edge slats, ailerons and flaps. These Self-Retracting Lanyards are the perfect choice to protect your valuable human and aviation assets at the same time!

Reliance SkyLoc™ II™ Aviation Series				
Part #	Working Length	Cable Type	Housing Material	Connector
4008025-1	25'	1/4" Braided DYNEEMA® Rope	Fiberglass Reinforced Nylon	3006 Double Locking w/ Swivel
4008040-1	40'	1/4" Braided DYNEEMA® Rope	Fiberglass Reinforced Nylon	3006 Double Locking w/ Swivel
4008050-1	50'	1/4" Braided DYNEEMA® Rope	Fiberglass Reinforced Nylon	3006 Double Locking w/ Swivel
4008080-1	80'	1/4" Braided DYNEEMA® Rope	Fiberglass Reinforced Nylon	3006 Double Locking w/ Swivel

# SkyLoc™ II SERIES

## Leading Edge

### Designed for Leading Edge Approaches and Sharp Edge Protection.

There are many circumstances where elevated anchorages aren't available and can't be improvised. This is where SRL-LE's (Self-Retracting Lanyards – Leading Edge) come in to play. ANSI/ASSP Z359.14 includes testing requirements utilizing a sharp leading edge in which the devices must be anchored at the deck and subjected to a dynamic performance test, which includes a free-fall distance in excess of five feet.

SkyLoc™ II SRL-LE's exceed the performance requirements of this standard and feature not only the requisite supplemental energy-absorber, but wire rope of increased diameter and strength (7/32"). Additionally, these devices utilize the same tried and true FailSafe® locking mechanism and rotary brake as the standard SkyLoc™ II.

We have included an integral clearance chart, site diagram and critical warnings on the energy-absorber for easy field reference. *Use of these devices is a last resort!* The best practice is to utilize an elevated anchorage directly above or adjacent to the working area. Use of these devices should be restricted to steel erection activities unless otherwise cleared by Reliance Engineering.



### SkyLoc™ II: SRL-LE Series Additional Features :

- Fiberglass reinforced nylon housing
- Load-bearing steel frame
- Over-sized steel anchor swivel
- Supplemental Energy Absorber
- 7/32" 7X19 Galvanized wire rope
- Exceeds the requirements of ANSI/ASSP Z359.14

### Reliance SkyLoc™ II Leading Edge Series

Part #	Working Length	Cable Type	Housing Material	Connector
4010020-1	20'	7/32", 7X19 Stainless Steel	Fiberglass Reinforced Nylon	3006 Double Locking w/ Swivel
4010030-1	30'	7/32", 7X19 Stainless Steel	Fiberglass Reinforced Nylon	3006 Double Locking w/ Swivel
4010040-1	40'	7/32", 7X19 Stainless Steel	Fiberglass Reinforced Nylon	3006 Double Locking w/ Swivel
4010050-1	50'	7/32", 7X19 Stainless Steel	Fiberglass Reinforced Nylon	3006 Double Locking w/ Swivel
4010065-1	65'	7/32", 7X19 Stainless Steel	Fiberglass Reinforced Nylon	3006 Double Locking w/ Swivel



# STOPLITE II®

## 410X Series



The StopLite II® Personal SRL is an update to our original StopLite® designed to reduce weight and improve performance. StopLite II® offers an unsurpassed level of safety, security and performance which challenge other products to keep up. This product exceeds ANSI and OSHA requirements by leaps and bounds and is manufactured using only the highest quality materials.

- High capacity energy absorber for improved performance
- Average arrest distances 10 - 20% less than standard limits
- Webbing strength exceeds standard minimums by >30%
- FailSafe™ cam-driven locking design guarantees locking engagements and is superior to centrifugal mechanisms

The StopLite II® can be attached quickly and easily to the back of a full body harness utilizing the Reliance SRL connector. Use of the connector allows for the attachment of either one or two Stop-Lite II® devices without sacrificing the availability of the back D-ring. These products may also be used in traditional applications, suspended from overhead anchorages in smaller work-spaces.

### Product Features

- External, High-Capacity Energy Absorber
- Lighter Weight and Extremely Durable
- High-Strength DYNEMA® webbing
- Four connector options
- Available in Singles and Twins
- Meets or exceeds OSHA and ANSI Z359.14 requirements.

### Specifications

- **Working Length** : 7 - 10 feet (2.13 - 3.05 m)
- **Height** : 4.125 inches (10.4cm)
- **Width** : 3.5 inches (8.9cm)
- **Depth** : 2.75 inches (7.0cm)
- **Weight** : 3.15- 8.2 lbs
- **Capacity** : One Worker up to 400 lbs (181kg) (worker, tools, equipment & clothing)

### Reliance StopLite II® 410X Series

Part #	Description	Working Length	Weight (lbs)	SRL Connector (4007-65)
4103-1	Single, Steelhead™ Snap Hook (Tie Back)	10'	3.15	No
4103T	Twin, Steelhead™ Snap Hook (Tie Back)	10'	6.60	Yes
4104-1	Single, Pelican Snap Hook	7'	2.90	No
4104T	Twin, Pelican Snap Hook	7'	6.00	Yes
4105-1	Single, Steel Rebar Hook	7'	3.75	No
4105T	Twin, Steel Rebar Hook	7'	7.80	Yes
4105T-S	Twin, Steel Swivel Rebar Hook	7'	8.20	Yes
4106-1	Single, Aluminum Rebar Hook	7'	3.40	No
4106T	Twin, Aluminum Rebar Hook	7'	7.20	Yes
4107-1	Single, Light-Weight Rebar Hook	7'	3.40	No
4107T	Twin, Light-Weight Rebar Hook	7'	7.15	Yes

# ROTO-LOC™

## Leading Edge Series

### Compact Design for Leading Edge Approaches and Sharp Edge Protection.

Tying off overhead is always the best decision you can possibly make when it comes to fall arrest. Sometimes, that isn't possible, and in those circumstances you may have to select an anchorage with a lower elevation or even tie-off at the foot-level. The Roto-Loc™ SRL-LE is designed for those circumstances. It features a unique mechanically activated rotary locking mechanism that ensures a rapid and secure locking engagement, no matter what. It also features an internal rotary brake, which is more efficient than textile energy absorbers commonly used on devices of this type. The 48" reserve line ensures that the device has plenty of reserve energy capacity.

These features work together to not only make the device safer and more reliable, they also provide the best performance possible and only require 13 feet of clearance (which includes a 2 foot margin of safety) in leading-edge falls! We also use a mil-spec wire rope of higher strength to ensure greater factors of safety.

Tying off at the feet while exposed to a leading or unprotected edge should only be done as a last resort. However, if that's the hand you've been dealt, then the Roto-Loc™ is like having an ace up your sleeve!



Model 4495006-1



Model 4485006-1

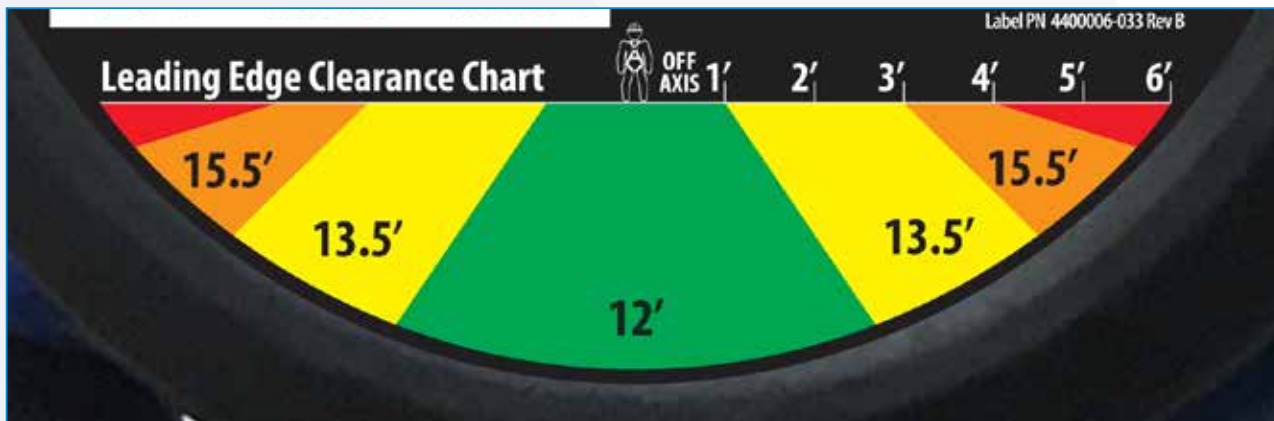

The Roto-Loc™ Leading Edge Self Retracting Lanyard includes a Leading Edge Clearance Chart for quick reference on the back so you always know the required clearance at any workable angle.

# ROTO-LOC™ Leading Edge Series

## Additional Features

- Internal rotary brake
- FailSafe locking mechanism
- 48" reserve line
- 3/16", 7 x 19 Mil Spec wire rope
- Available in single and twin configurations
- Rugged housing with protective overmold
- Only 12 ft required clearance (perpendicular approach)
- Housing Type: Sanoprene over ABS
- Housing Dimensions: 8"L x 5"W x 3.5"H (20.3cm x 12.7cm x 88.9cm)



Model 4496006-1



### Reliance Roto-Loc™ Leading Edge Series

Part #	Working Length	Line Type	Weight (LBS)	Configuration	Hook Type
4485006-1	6' (1.8m)	3/16" (4.5mm) Galvanized	4.9	Single	3006WR Pelican ZN Plate
4486006-1	6' (1.8m)	3/16" (4.5mm) Galvanized	5.6	Single	3011WR Rebar ZN Plate
4487006-1	6' (1.8m)	3/16" (4.5mm) Galvanized	5.1	Single	Steelhead HD ZN Plate
4480006-1	6' (1.8m)	3/16" (4.5mm) Galvanized	5.5	Single	Pelican Swivel ZN Plate
4495006-1	6' (1.8m)	3/16" (4.5mm) Galvanized	10.1	Twin	3006WR Pelican ZN Plate
4496006-1	6' (1.8m)	3/16" (4.5mm) Galvanized	11.5	Twin	3011WR Rebar ZN Plate
4497006-1	6' (1.8m)	3/16" (4.5mm) Galvanized	10.5	Twin	Steelhead HD ZN Plate
4490006-1	6' (1.8m)	3/16" (4.5mm) Galvanized	11.3	Twin	Pelican Swivel ZN Plate

# SkyLoc™ SRL

## Proven Performance

SkyLoc™ Self Retracting Lanyards are designed to arrest a fall in 2' (.6m) or less and limit the maximum arresting force (MAF) to 900 lbs (4 kN) Deceleration distance will not exceed 42" (1.1m).

### SkyLoc™ Features:

- Lightweight thermoplastic case
- Two fast and positive cam-driven locking pawls
- Available with cable or polyester web
- Forged steel Pelican hook



### Reliance SkyLoc™ Series

Part #	Working Length	Cable Type	Housing Material	Connector
4015-1	18'	3/16" Galvanized	Thermoplastic	3006 Double Locking w/ Swivel
4020-1	20'	1" Polyester Web	Thermoplastic	3006 Double Locking w/ Swivel

# ENERGY ABSORBING LANYARDS



**VERSATILE SOLUTIONS FOR  
JOBSITE CHALLENGES**



# LIGHT WEIGHT HOOKS

## Light Weight Steel. Heavy Performance.

The Reliance snap hook assortment has been at the leading edge since the development of our Steelhead™ hook, more than 13 years ago. The national consensus standards requirements for gate strength were increased in 2007 in large part due to the introduction of the Steelhead™. Over the years, there has been an increased demand for lighter weight connectors, stimulating the introduction of many aluminum carabiners and snap hooks in the market place. The downside is that when eccentrically loaded, aluminum simply struggles to measure up.

We are pleased to introduce a reduced weight snap hook and rebar hook, forged from chro-moly steel according to our patented design. These hooks rival the light weight of aluminum with far superior strength and security. We are in the process of integrating these hooks as standard equipment on our line of energy absorbing lanyards. Keep it real, go with steel!

### Light Weight Rebar Hook

**Part Number: 3011-WR**

Based on our classic 3011 fan-gate design, this rugged rebar hook tips the scales at only 1.35 lbs vs. the 1.75 lbs in our previous design. Additionally, this hook exceeds the 3,600 lb transverse-load requirements of the soon-to-be published revision of the ANSI/ASSE Z359.12 connector standard. Most aluminum rebar hooks today will fail to meet those requirements when the standard takes effect in late 2018.

### Specifications

Material: SAE 4140 Alloy Steel  
 Finish: Yellow Chromate  
 Strength:

- Major Axis: 5,000 lbs +
- Gate Face: 3,600 lbs +
- Side Load: 3,600 lbs +
- Transverse Load: 3,600 lbs +

Weight: 1.35 lbs  
 Standards: Meets the requirements of ANSI/ASSE Z359.12, Title 29 CFR, Subparts I & M



### Light Weight Pelican Hook

**Part Number: 3006-WR**

Based on our classic 3006 "Pelican head" design, this snap hook weighs only .75 lbs as opposed to the .95 lb weight of its predecessor.

This hook is being introduced to the line-up first in our Stoplite II series of personal SRLs and will be available as a part of a new series of lanyards in the second half of 2018. They can be utilized in existing products on request – contact a Reliance distributor for additional details.

### Specifications

Material: SAE 4140 Alloy Steel  
 Finish: Yellow Chromate  
 Strength:

- Major Axis: 5,000 lbs +
- Gate Face: 3,600 lbs +
- Side Load: 3,600 lbs +
- Transverse Load: N/A

Weight: .75 lbs  
 Standards: Meets the requirements of ANSI/ASSE Z359.12, Title 29 CFR, Subparts I & M



# POSITIONING DEVICES

Positioning devices effectively limit a worker's exposure to potential fall hazards and are designed to perform in the toughest of environments.



**Rebar Chain Assembly 726001**  
 14", 2 ea 3/4" hooks, 1 ea 2-1/4" hook



**Positioning Lanyard 711954**  
 1" polyester, web loop, 3/4" snap hook



**Adjustable Lanyard 717106**  
 3.5' - 6', 1" polyester, 2 ea 3/4" snap hooks

## SKYLINE SERIES

The Skyline™ shock absorbing lanyard represents the industry standard in single-leg shock absorbers. They feature Reliance's patented "Tattletale"™ webbing, making inspection quick and easy. Skyline™ lanyards are rigorously tested to comply with the most stringent ANSI standards, and are available with a variety of hooks for use in all types of environments.



### Skyline 732101

Shock Absorber, 3/4" hook, screw lock



### Skyline 731406

Lanyard, 3/4" hook, 3/4" tieback hook



### Skyline 731126

Lanyard, 2 ea 3/4" hooks, tie-back ring



### Elastic Skyline 735206

Lanyard, 3/4" hook, 2-1/4" rebar hook



### Adjustable Skyline 737106

Shock Absorber, 2 ea 3/4" hooks



### Adjustable Skyline 737406

Lanyard, 3/4" hook, 3/4" tieback hook



### Adjustable Skyline 737206

Lanyard, 3/4" hook, 2-1/4" rebar hook

## FATPACK™ SERIES

Reliance twin-leg lanyards use a FatPack™ shock absorber. The FatPack™ gets that name because it has two complete and independent shock absorber assemblies inside the same shock pack, making it fatter than a normal single shock pack. If both lanyard legs are connected to just one shock pack, the leg that is extending will pull the other lanyard leg with it. If that leg is connected to the worker at the harness hip D-ring, that hip will be jerked instantly upward toward the anchorage point by the extending shock absorber. The two independent shock absorbers in the same shock pack are able to absorb this "second" impact, reducing the possibility and severity of injury.



### FatPack™ 741206

Lanyard, 3/4" hook, 2 ea 2-1/4" rebar hooks



### FatPack™ 741646

Lanyard, web loop, 2 ea 3/4" tieback hooks



### FatPack™ 741406

Lanyard, 3/4" hook, 2 tieback Steelhead hooks



### Cable FatPack™ 744206

Lanyard, 3/4" hook, 2 ea 2-1/4" rebar hooks



### Kevlar® FatPack™ 749406

Lanyard, 3/4" hook, 2 tieback Steelhead hooks

# BLACKMAX™ SERIES

The BlackMAX™ shock-absorbing lanyard is the first of its kind. It “knows” how far the worker has fallen and can regulate the arresting force depending on the circumstances. It is designed to arrest falls in both “Force Level 1” (6’ free-fall) and “Force Level 2” (12’ free fall) (1.8 & 3.6m) conditions. This eliminates the need for 2 styles of shock-absorbing lanyards for employees that may be exposed to both potential fall conditions throughout the workday.



**BlackMAX™ 731700**  
Lanyard, 3/4” hook, tieback Steelhead hook

**BlackMAX™ 741700**

Lanyard, 3/4” hook, 2 ea tieback Steelhead hooks



# BIGBOY™ SERIES

The BigBoy™ series of shock absorbing lanyards was designed for use by persons with a total body and tool weight greater than 310 lbs. (140kg). If deployed, the Maximum Arresting Force (MAF) will not exceed 1800 lbs.(8kN), and lanyard elongation will not exceed 42” (1.1m) - in adherence with existing requirements for equipment designed for users with a total body and tool weight of less than 310 lbs.



**BigBoy™ 751106**  
Lanyard, 2 ea 3/4” hooks



**BigBoy™ 751206**  
Lanyard, 3/4” hook, 2-1/4” rebar hook



**Adjustable BigBoy™ 762206**  
Lanyard, 3/4” hook, 2 ea 2-1/4” rebar hooks



**BigBoy™ 761106**  
Lanyard, 3 ea 3/4” hooks



**BigBoy™ 761206**  
Lanyard, 3/4” hook, 2 ea 2-1/4” rebar hooks



**Adjustable BigBoy™ 767406**  
Lanyard, 3/4” hook, 2 ea tieback Steelhead hooks

# QUICKSTOP™ SERIES

The QuickStop™ series of shock absorbing lanyards is “Tuned” to greatly reduce deceleration distance in the event of a fall. These lanyards are designed for use in areas where clearance to the next lower level is less than 14’ (4.2m). Maximum Arresting Force (MAF) will not exceed 1800 lbs (8kN).



**2.5' QuickStop™ 731622**  
Lanyard, 3/4” Steelhead hook, 2-1/4” rebar hook



**3' QuickStop™ 731623**  
Lanyard, 3/4” Steelhead hook, 2-1/4” rebar hook



# ANCHORAGE CONNECTORS



**SECURITY THROUGH  
INNOVATION**



# ADJUSTABLE WIDTH BEAM ANCHORS

\*Anchors may be used over head or at foot level when used with the BlackMax™ shock absorber

Adjustable Width Beam Anchors are temporary (movable) anchorages designed for use in steel erection. The steel bar, aluminium jawed HLL anchor clamp can be used to anchor a Horizontal Lifeline System, or as an anchor point for a personal fall arrest system.

Sliding Beam Anchors combine freedom of movement and dependable fall protection. When attached to a beam, the anchor trails behind the user through attachment of a shock absorbing lanyard. Anchors are simple to install, remove, and size, with no pins or chains. Dual beam grip adjustment prevents twisting and turning as it moves along the beam, and synthetic wear pads are replaceable.

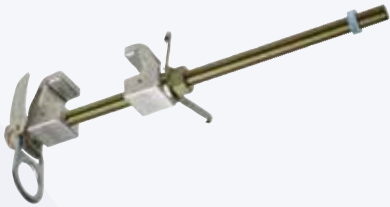

**Adjustable Beam Anchor 3093-1**  
Fits I-Beams with 4" -16-5/8" flanges & 1/4" - 1-3/4" flange thickness



**Adjustable Beam Anchor 3098-1**  
Fits I-Beams with 4" -16-5/8" flanges & 1/4" - 1-3/4" flange thickness, dual anchor rings



**Adjustable Bypass Anchor 3091-1**  
Temporary HLL Bypass Clamp. Fits I-Beams with 4" -16-5/8" flanges & 1/2" - 1-3/4" flange thickness.



**Adjustable Sliding Beam Anchor 3096-1**  
Fits flange 3-3/4" - 12-1/2" wide & 1/4" - 1-1/4" thick

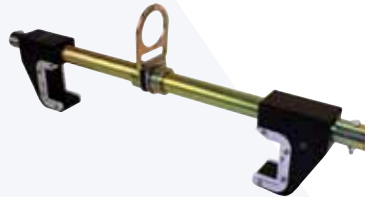

**Adjustable Sliding Beam Anchor 3097-1**  
Fits flange 5-1/2" - 18" wide & 1/4" - 2-1/2" thick



**Adjustable Sliding Beam Anchor 3104-1**  
Fits flange 5-1/2" - 26" wide & 1/2" - 3" thick



**Adjustable Sliding Beam Anchor 3108-1**

- Fits flange 4" - 14.5" wide & 1/4" - 1-1/4" thick
- Ratcheting jaws adjust with trigger for easy installation
- UHMW rollers for top-of-flange trailing
- Ideal for steel erection activities and long-term use in structural steel environments
- 3.75 lbs total weight



The Screwjack™ Personal Fall Arrest Anchor Clamp utilizes a swivelling D-ring to create a compatible attachment point for a single-user personal fall arrest system. The jaw can be adjusted to proper width, placed over the beam, and secured in place with the locking detent pin. With the screw adjustment feature, the clamp can then be securely attached to vertical or inclined beams to prevent movement.



**Screwjack™ Adjustable Beam Anchor 3100-1**  
Fits flange 3-3/4" - 14" wide



**Screwjack™ Adjustable Beam Anchor 3102-1**  
Fits flange 5-1/4" - 24" wide & 1/4" - 3" thick

# ANCHORAGE CONNECTORS



## Permanent Anchor 3071-1

Attaches to the side of vertical beams or structural steel supports. Zinc plated carbon steel.



## Removable Concrete Anchor 2267-1

Use in horizontal, vertical or overhead surfaces. 2267: 5k lb capacity; 2268: 10k lb capacity



## Mega Swivel Anchor 3078-1

Stainless steel. 360° rotation, 180° deflection.



## Mega Swivel Puck Kit 3079-1

Weld-on puck kit for Mega Swivel includes a 5/8" X 3-3/4" 304 stainless bolt, washer and lock nut and is ideal for harsh environments where corrosion is a concern.



## Concrete D-Ring Anchor 3070-1

Temporary or permanent. Reusable D-Ring. Installs into 11/16", 3/4", or 18mm holes.



## Weld-On D-Ring Anchor 3068-1

Can be welded to structure for a permanent, rated anchor point. Formed flat bar can be painted after welding.



## Bolt-On D-Ring Anchor 3066-1

Bolts into two 1/2" diameter drilled holes in I-beams or other structure. 5,000 lb. anchor-age, zinc plated carbon steel.



## Weld-On Lugs 61XX-1

Single & double-hole for HLL or tie-back anchorages. Available in stainless or alloy steel. 6158-1: single hole alloy, 6160-1: single hole stainless, 6161-1: double hole alloy, 6162-1: double hole stainless

# CONCRETE EMBED ANCHOR SYSTEM



Receiver is cast into place, to 10,000 lb. anchor strength. Anchors tie into rebar to provide increased strength in green concrete. One ball-lock connector can be used with numerous inexpensive receivers. Remote connect/disconnect, up to 20' overhead.



**Metal Decking Insert 2243-1**  
Attaches receiver to 2" holes in decking. Eyebolt used to remove insert after pouring. 2241: Urethane insert only.



**Anchor Ring 2280-1**  
5k lb anchor, permanent installation into receivers.



**Bypass Ring 2270-1**  
Bypass for horizontal lifeline.



**Concrete Embed Anchor 2260-1**  
Available in carbon or stainless steel. Provides up to 10,000 lb. anchor when attached to receiver. May be used for one or two man anchor or to anchor horizontal lifelines.

# REMOTE ACCESS ANCHOR SYSTEM

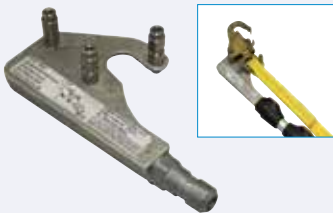

**Remote Saphook Connector 3021-1**  
Attaches to end of 3022-1 pole and allows user to attach 3006 saphook to overhead anchorage point. May also be used for a remote connection in rescue scenarios.



**Socket 3022-17**  
Used with 3040 hook and 3022 pole.



**Lockjaw™ Beam Grip 3040-1**  
Attaches to I-beams 5"-12". Aluminum jaws, steel swivel. 10k lb anchor point.

**Remote Anchor Pole 3022-X**

Used with the 2260 concrete embed connector, 3040 lockjaw and the 3021 Remote Connector tool. (shown with the 2260 probe). Extends up to 13': 3022: pole only, 3022-2: pole and socket for use with 3040, 3022-3: for use with 2260 (includes probe), 3026: pole with 9' extended length.



# ANCHORAGE CONNECTORS



## Bow Shackles 606X-1

6062: 1/2" stainless  
 6066: 5/8" stainless  
 6063: 1/2" galvanized  
 6067: 5/8" galvanized

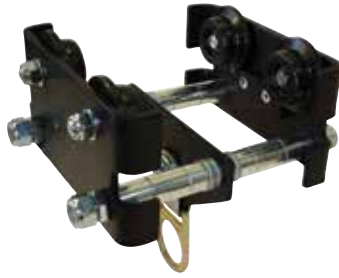

## Removable Beam Trolley 4800-1

Use on beam flanges 3 - 8.7" wide & from 3/16 - 3/4" thick. Minimum distance between flanges is 5".



## Permanent Beam Trolley 4850-1

Permanent installation on 4" to 16.5" flanges. Corrosion resistant UHMW wheels, SS bearings, powder coated aluminium body. FDA approved for contact with food products.



## Web Anchor Sling 68000X

9,600 lb. web sling with abrasion protector, 3" and 2" D-rings. 680002: 2', 68003: 3', 680004: 4', 680005: 5', 680006: 6', 680007: 7', 680008: 8'.



## I/Concrete Beam Anchor Strap 609X-1

6095: I-Beam Anchor Strap with wear sleeves. 3" X 6' length. 6096: Concrete Beam Anchor Strap with wear sleeves 3" X 15' length.



## Wire Rope Sling Anchors 714XXX

Available in a variety of styles, lengths, and configurations (pelican hook/O-ring, pass-thru rings, pelican hook/dual rings). Cable: 1/4" 7X19 GAC with blue vinyl coating. Snap Hook: 3006 3,600 lb. Gate load. Pass-Thru Rings: Zinc coated steel. From 2' to 15' lengths - contact Reliance for details.



## Scaffold Anchor Sling 687000

1" X 17" with D-ring



## Structural Steel Anchor 3069-11

One hand operation. Fits holes with diameter from 13/16" - 7/8" and a wall thickness of 3/8" to 1-9/16". 5,000 lb. rated anchorage point. Drop forged eye bolt.



## Modified Toggle-Lock Anchor 2269-1

Developed exclusively for Reliance to provide a secure connection in steel I-beam flanges and in hollow pre-cast concrete applications. Meets all applicable standards requirements and is rated for use by a single user.

# BIGBLUE™ MOBILE ANCHOR SYSTEM SERIES



The BigBlue™ Mobile Anchorage System is designed to create a portable, overhead anchorage for use adjacent to fall hazards where overhead structures may not be available to create an effective fall arrest anchorage connection. When used with a properly rated Class A Self-Retracting Lanyard, Arrest distances are less than 24", making this a perfect solution for low-clearance applications.

This device ships unassembled (ballasting material not included) and can be erected by two persons in under 45 minutes. The BigBlue™ Mobile Anchorage System can be ballasted with either construction sand or concrete. This is perfect solution for use in marshalling and accessing free-standing structures and heavy equipment such as electrical transformers and heavy vehicles.

## Product Features

- Provides a mobile, overhead anchorage for fall arrest.
- Jib-arm rotates 360° for proper adjacency.
- Jib-arm features a traversable trolley to assist with proper fall arrest alignment.
- Flexible ballasting system allows the use of either sand or concrete.
- Forklift and/or pallet jack portable.
- Rugged, powder-coated steel construction.
- Designed for use with a Class A SRL (Z359.14-2014)

## Specifications

- Working height : 23.5'
- Jib arm length : 8'
- Base dimensions : 55" w x 55" l x 25.5" h
- Total minimum weight : 6,000 lbs.
- Capacity : 1 worker, 310 lbs max. weight (worker, tools & equipment)
- Model # for the kit as pictured : 1801000-1

# CONFINED SPACE ENTRY & RETRIEVAL



**WORK SAFELY FROM  
START TO FINISH**

# CONFINED SPACE TRIPOD KITS

The Reliance Confined Space Tripod Kits combine some of our best fall protection technologies into a variety of user-friendly configurations to provide an unmatched level of protection for Confined Space Entry and Rescue.

## 1820001-1 Tripod, Confined Space



### Materials

- Head: Cast Aluminum
- Swivel Anchor Eyes: Stainless Steel
- Pulleys: Alloy Steel, Aluminum Wheels
- Legs: Aluminum, Extruded
- Ball-Lock Pins: Stainless Steel

### Specifications

- Weight: 50 lbs.
- Height: 64" – 94"
- Min. Strength: 5,000 lbs

Meets or Exceeds the Requirements of ANSI/ASSP Z359.1

Durable aluminum construction is 7.5' tall and features a cast aluminum head with dual pulleys and dual swiveling anchor points. Locking detents make erection easy and safe, and locking detent pins are included for security and added strength. Collapses to 64", weighs only 50 lbs and includes a storage bag.

## 4502-1 Personnel Hoist



### Materials

- Winch Body: Alloy Steel
- Wire Rope: 3/16" 7x19, galvanized
- Snap Hook: Alloy Steel (Z359.12)

### Specifications

- Weight: 27 lbs
- Min. Strength: 3,600 lbs

This rugged hoist includes a high duty-cycle brake, dual pawls and has a secondary, mechanically-activated locking mechanism. It also features a personal energy absorber to protect against unintended falls. Energy absorber includes a static load cable that only deploys under a dynamic event and provides a load indicator in the event of a fall.

# Reliance EnviroShield®. Built to Last.

## Exceeding ALL Standard & Regulatory Requirements

When creating this Confined Space SRL with Integral Rescue Device, we chose to build it on our best platform – the EnviroShield environmentally sealed SRL. This device meets the stringent IP69K requirements for ingress protection against both dust and high-pressure, high-temperature fluids and also passes a 1,000 hour salt-spray. The rescuer element is easily engaged and disengaged and features a telescoping and collapsible winch handle. Our design also ensures that the SRL's locking mechanism is never bypassed and remains available as an effective redundant fall arrest component.

## 4120XXX-2 EnviroShield SRL-R\*



**NO Shortcuts.**

### Materials

- Housing: Aluminum and Stainless Steel
- Wire Rope: 3/16" 7x19, Stainless Steel
- Carabiner: Stainless Steel (Z359.12)

### Weight

- 4120050-2: 50 lbs
- 4120085-2: 55 lbs
- 4120130-2: 72 lbs
- MAF: ≤ 1,800 lbs
- AAF: ≤ 900 lbs
- AD: ≤ 42"

Meets or Exceeds the Class B and SRL-R Requirements of ANSI/ASSP Z359.14



# The Right Combo for The Right Fit

Top shelf features on all of the components of the system. Easy to read labels that help the user quickly assemble and erect the tripod, and guide the user through the SRL-R Rescuer activation. Lift in place brackets for both the Hoist and SRL-R Rescuer. Collapsible and pivoting two speed handle on the SRL-R Rescuer. Patented cable stacking nozzle on the SRL-R Rescuer to ensure dependable cable retraction. Easy to adjust leg base chain for the Tripod. Multi-position legs for perfecting the working height of the Tripod. Twin integral pulleys on the Tripod to reduce cost and complexity of the system. All features are designed with the operator in mind, to keep them safe and engaged in worksite safety.



## Reliance Confined Space Tripod Kit Components

Part Number	Description
1820001-1	Tripod, Confined Space
1820002-1	Confined Space Kit, Tripod + Hoist (1820001-1 + 4502-1)
1820501-1	Confined Space Kit, Tripod + 50' EnviroShield SRL-R (1820001-1 + 4120050-2 + 4511-1)
1820851-1	Confined Space Kit, Tripod + 85' EnviroShield SRL-R (1820001-1 + 4120085-2 + 4511-1)
1821301-1	Confined Space Kit, Tripod + 130' EnviroShield SRL-R (1820001-1 + 4120130-2 + 4511-1)
1820502-1	Confined Space Kit, Tripod + Hoist + 50' EnviroShield SRL-R (1820001-1 + 4502-1 + 4120050-2 + (2)4511-1)
1820852-1	Confined Space Kit, Tripod + Hoist + 85' EnviroShield SRL-R (1820001-1 + 4502-1 + 4120085-2 + (2)4511-1)
1821302-1	Confined Space Kit, Tripod + Hoist + 130' EnviroShield SRL-R (1820001-1 + 4502-1 + 4120130-2 + (2)4511-1)
4120050-2	EnviroShield SRL-R, Confined Space Fall Arrest Rescuer, 50', W/Confined Space Bracket
4120085-2	EnviroShield SRL-R, Confined Space Fall Arrest Rescuer, 85', W/Confined Space Bracket
4120130-2	EnviroShield SRL-R, Confined Space Fall Arrest Rescuer, 130', W/Confined Space Bracket
4502-1	Personnel Hoist, Confined Space, 60'
4511-1	Tripod Mounting Bracket for Hoist and Rescuer

# CONFINED SPACE SYSTEM

\*Winch and SRL sold separately



## 5 Piece Confined Space Entry System 4600

The 5 Piece Confined Space Entry System provides a means of portable overhead entry, fall arrest and rescue. It breaks down into five lightweight aluminum components for easy storage, transportation and setup. The modular design allows the adjustable mast to be fitted to various fixed and portable bases, providing maximum worksite flexibility dependent upon the requirements of the environment. When fitted with the 4502-1 hoist and an Enviroshield SRL-R, this system will get workers in and out safely - whether it is a manhole, a storage tank or any other confined space requiring vertical entry.

# CONFINED SPACE ACCESSORIES

## Rescue Wristlets 722001

Designed for confined space extraction. Straps fit over wrists or ankles.



## Retrieval Lanyard 722000

Designed for use with the 804XXX and the 814XXX series harness's from Reliance Industries. The encapsulated steel spreader bar is intended to keep the shoulder D-Rings properly spaced to prevent pinching of the neck during confined space rescue and retrieval operations.



## Rescue Ladder & Bracket 52XX-1

Rescue Ladder Bracket (5200) is designed to travel on a horizontal lifeline with the 2 supplied cable pulleys. Ladder can be sent to a fallen worker for rescue. Once on the ladder the worker can be hauled back to safety.

52XX Rescue ladders are made from 1-1/4" (32mm) extruded aluminium rungs and 3/16" (4.7mm) stainless steel wire rope side rails. Comes with 2 ea. 3062-36 carabiners. Meets ANSI E1.1 Standard lengths: 5210: 10', 5220: 20', 5230: 30', 5240: 40', 5250: 50' and 5260: 60'. Custom lengths available.



## Bosun's Chair 885051

Seat board (12"x24"x1". Integrated tongue buckle body belt, single forged D-Ring suspension point (Must be used with additional PFAS).



# SYSTEMS

## HORIZONTAL & VERTICAL



**PRECISION  
ENGINEERING**



# HORIZONTAL LIFELINE SYSTEMS

Reliance horizontal lifeline systems use Tuned Cable® technology. Cable tuning (or the use of high pre-tensioned cables) has been shown to significantly reduce fall arrest distances and line tensions during fall arrest. This is accomplished using a scientifically tuned HLL cable that reduces the input momentum of a falling weight and at the same time forces the cable to absorb the energy generated during a fall at a higher rate. This allows the design of systems with longer line lengths and lower final line tensions than previously thought possible. This also creates the need for fewer bypass supports to reduce line tension, thus lower overall system cost.

## Tuned Cable® technology permits:

- Free spans up to 200' (61m) without intermediate supports
- Lower end loads, which means easier installations in more and different locations
- Multiple end-anchor choices for every situation: rebar clamps, concrete beam straps, anchors, concrete inserts, weld-on lugs, bolt-on clamps, I-Beam clamps and more
- A choice of stanchions to raise the lifeline above the walkway or with in-line clamps where overhead structure exists
- All systems are available with bypass supports to reduce line tension and limit fall distances

Reliance systems are engineered, and comply with all applicable OSHA and ANSI requirements and standards. They are supplied with complete documentation so they will meet the requirements for anchorage performance, design and component traceability for OSHA inspections. - and at a reasonable price.

## Reliance Horizontal Lifeline Wizard

The Reliance Horizontal Lifeline Wizard is an exclusive on-line tool which utilizes empirical data derived from over 200 live tests, allowing qualified end-users to configure their systems according to their needs. Once the desired outputs are generated, a detailed engineering report and bill of materials are generated. The performance data and engineering report can be saved to individual profiles for future reference.

Through use of the Reliance 'Horizontal Lifeline Wizard' on the Reliance website at [www.relsafe.com](http://www.relsafe.com). Anticipated lifeline tension and minimum required clearance beneath the walking surface are determined instantly by entering the following five items :

- Number of system users required
- Total lifeline length
- Number of intermediate supports
- Type of deceleration device used
- Elevation of lifeline above walking surface

Since the calculations are almost instant, many design combinations may be viewed to obtain the best design for protection of the affected workers. The program will automatically invalidate the system if it is not viable based on the entries. When a viable system is configured, the user can generate a bill of material based on the components required for the system designed.

Our skilled team of engineers are always accessible and happy to answer questions and provide additional guidance for larger, more challenging projects. The unrivaled performance of the Skyline Horizontal Lifeline Systems coupled with the personalized customer service and technical support from our engineering team ensure the best protection that money can buy!

Proposed Data	
Anchor Elevation (m)	0.000
Anchor Elevation (ft)	0.000
Number of Users	2
Number of Supports	4
Total Span Length (m)	100.000

Estimated Values	
Min. Required Clearance (m)	1.000
Intermediate Anchor Spacing	50.000 (ft)
Maximum Length (m)	50.000
Number of End Supports	2
Number of Cable Segments	3
Minimum HLL Clearance	0.400
HLL Line Clearance (m)	0.400
Total Vertical Length	4.000
Minimum Anchor Extension (m)	0.000
Free Fall Clearance (ft)	0.000
Free Fall Clearance	0.000
HLL Top Height (m)	0.400

Utilizing your own exclusive profile, you can use the HLL System Calculator to configure your lifeline for optimum performance and then proceed to the Wizard functions to select the components required for your application by navigating a simple series of options and drop-down menus. The wizard will allow you to export your custom bill of materials, complete with list pricing to either a PDF or an Excel worksheet for easy planning and documentation.



**Road & Bridge:** Reliance offers a variety of engineered horizontal lifeline systems that are specifically designed to address the fall protection hazards associated with the construction and maintenance of roadways and bridges. These systems use components that were developed to meet the standard requirements of road and bridge work environments, and have been thoroughly field tested on actual jobsites. Reliance Horizontal Lifeline Systems for Road and Bridge work share a common horizontal lifeline system, but use different anchor, stanchion, and other elements specific to the environment in which they are installed.

### Road & Bridge Anchorage Options : Looped Rebar, Nelson Stud, Structural Steel, Pour-In-Place Concrete



**Structural Steel:** Structural steel systems are designed for installation on existing structures. Utilizing off the shelf components, most all structures can be accommodated. System height is 5, 6, or 7' (1.5, 1.8, 2.1m) above the walking surface or can be configured to hang from above. System stabilization is maintained with tie-back cables or strong back struts when stanchions are utilized. On structures (piperacks) where clamping on the top flange of I- beams is not feasible, under slung clamps may be used.

### Structural Steel Anchorage Options : Clamp-On, Weld-On, Choker Strap, Overhead, Fireproof or Boxed Beam



**Concrete:** Construction projects utilizing concrete foundations are among the most common in building sites worldwide. The nature of concrete construction projects presents a unique set of challenges for fall protection and horizontal lifeline setup and use. Reliance has extensive experience in this area, and offers a variety of systems and solutions for concrete construction projects.

Currently, Reliance offers several off the shelf systems which effectively address most concrete construction applications. Since each project has unique challenges, custom fabrication of brackets and structural interfaces are available upon request.

### Concrete Anchorage Options : Bolt-In, Commercial Rebar, Drop-In Sleeve, Rebar Direct Connect, Embedded



**Specialty Systems:** With our large selection of off the shelf components, most any structure may be fitted with a permanent or temporary Reliance horizontal lifeline. With the ability to "tune" our lifeline systems, Reliance can accommodate clearance and span geometries that our competitors have difficulty with.

**CONTACT RELIANCE FOR COMPLETE INFORMATION  
ON ALL HORIZONTAL LIFELINE SYSTEMS**

### Specialty System Options : Inverted 'L'; Strongback™

# SKYLINE™ TEMPORARY HORIZONTAL LIFELINE

The Reliance Skyline™ Temporary Horizontal Lifeline System is unlike anything else available in today's market. It is adaptable to virtually any construction environment and can be installed between fixed anchorages or as a free-standing system at elevations of five, six or seven feet.

When we couple the elevation with the patented high-tension cable-tuning technology, we achieve the shortest arrest distances possible, allowing these systems to be utilized in areas where clearance is limited and traditional, extensible systems are not viable.

The Reliance Horizontal Lifeline Wizard is an exclusive on-line tool which utilizes empirical data derived from over 200 live tests, allowing qualified end-users to configure their systems according to their needs. Once the desired outputs are generated, a detailed engineering report and bill of materials are generated. The performance data and engineering report can be saved to individual profiles for future reference.

The Reliance Skyline Temporary Horizontal Lifeline System is the highest performing, most flexible system available, and the on-line Wizard makes system design and implementation simple. It is the perfect solution for providing a contiguous fall arrest anchorage for one to four users in steel erection, road and bridge construction or any other construction application where substantial structures are available.

Free-spans of up to 200 feet are possible, with sufficient clearance and all of the components are interchangeable, allowing these systems to be re-purposed for future projects. We have developed a broad range of stanchion bases allowing these systems to be adapted to virtually any substrate.



## System Capability and Clearance Requirements

### Reliance Skyline HLL - 120' Free Span System, 4 Users

A free-span of 120 feet with FOUR users using personal SRLs requires only 13'8" of clearance below the walking-working surface and includes a 2' safety factor.

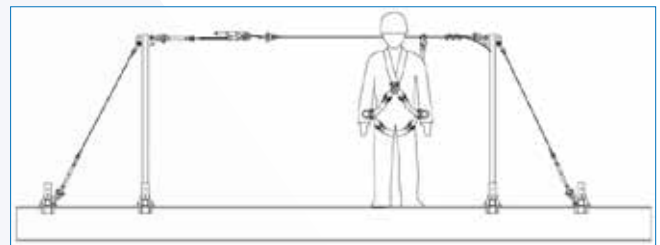

### Reliance Skyline HLL - 120' Span, 1 Mid-Span Support, 4 Users

A single 120 foot system with a mid-span support with FOUR users using personal SRLs requires only 10'9" of clearance below the walking-working surface and still includes a 2' safety factor!

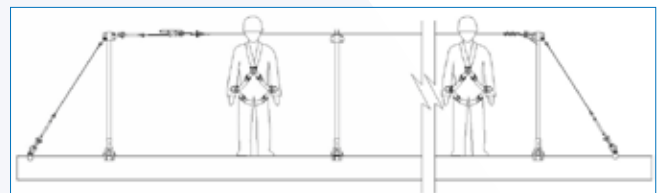

***The Reliance Skyline HLL System will span twice the distance and protect twice as many workers with 25-40% less clearance required below the walking-working surface than typical competitive systems.***

# SKYLINE™ TEMPORARY HORIZONTAL LIFELINE

Skyline HLLs can be used in a variety of environments for temporary applications related to construction, turn-arounds and access to areas requiring infrequent access. The core of the system is the 6310 Horizontal Lifeline Kit, which contains the actual lifeline components common to all Reliance Temporary Horizontal Lifeline Systems.

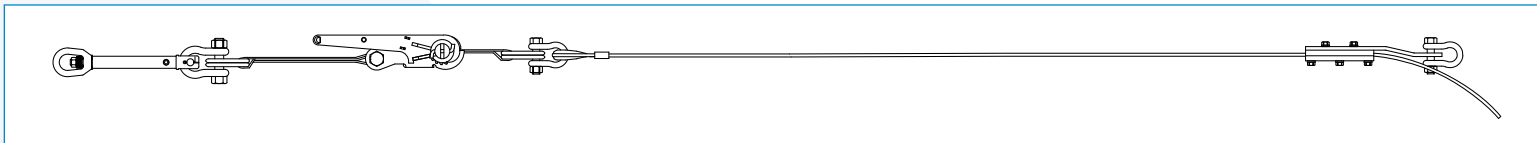

## 6310 System Components



Ratchet Strap 6092-1



In Line Cable Clamp 6050-1



In Line Energy Absorber 6000-1



Bow Shackles (4 ea) 6062-1



Ratchet Assembly 6090-1



Cable 6070-X Standard lengths available

## Structural Anchorage Systems for use with Temporary Systems



HLL Bypass Beam Clamp 3091-1  
Fits 4" - 16 5/8" width / 1/4" - 1 3/4" thick



HLL Anchorage Beam Clamp 3093-1  
Fits 4" - 16 5/8" width / 1/4" - 1 3/4" thick



HLL Double End Anchorage Beam Clamp 3098-1  
Fits 4" - 16 5/8" width / 1/4" - 1 3/4" thick



6' Anchor Strap 6095-1  
6096-1 = 15'



Ratchet Strap Bypass Assembly 6172-1

# SKYLINE™ FREE-STANDING HORIZONTAL LIFELINES

## Horizontal Lifeline End / Bypass Stanchions

Free-standing systems can be affixed to virtually any structure when the stanchions are paired with the correct anchorage base. Stanchions come in 5', 6' and 7' heights to ensure that the level of the anchorage is elevated sufficiently to reduce free-fall distances.

## Structural Steel Anchorage Bases

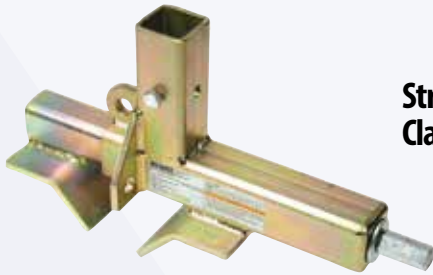

**Structural Steel Base Clamp 6240-1**



*Bypass configuration is enabled by simply reversing the direction of the stanchion head.*

**End/Bypass Stanchion - 84" 6163-1**  
6178 - 72"  
6151 - 60"

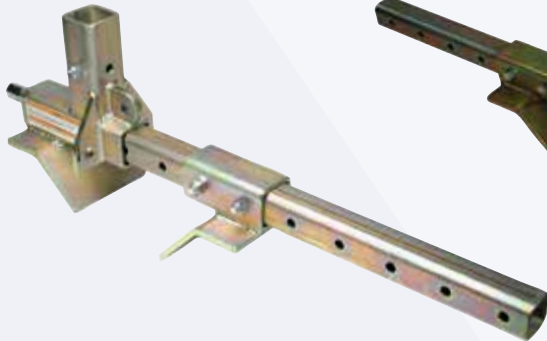

**Structural Steel Base 6230-1**



**Structural Steel Base 6231-1**



**Adjustable Tieback Cable 6077-XX**

1/2" - 6X19 (XX denotes length)  
Used to tension & support end stanchions

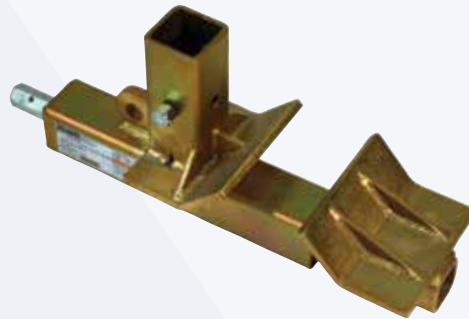

**Structural Steel Base 6235-1**





# SKYLINE™ FREE-STANDING HORIZONTAL LIFELINES

## Road & Bridge | Concrete System Anchorage Bases

Reliance offers a variety of engineered horizontal lifeline systems that are specifically designed to address the fall protection hazards associated with the construction and maintenance of roadways and bridges, and concrete construction projects - which present a unique set of challenges for fall protection and horizontal lifeline setup and use. These systems use components that were developed to meet the standard requirements of their specific work environments, and have been thoroughly field tested on actual jobsites. Road & Bridge and Concrete-Specific systems share a common horizontal lifeline system, but use different anchorage bases, tiebacks, and other elements specific to the environment in which they are installed.

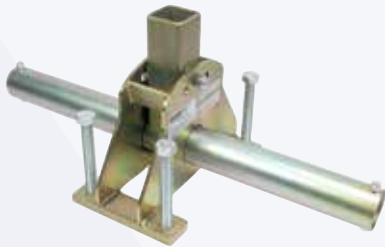

**Receiver Bracket for Looped Rebar HLL Systems 6170-1**  
For use with standard 2" end/bypass stanchions

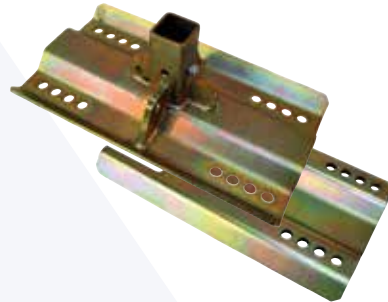

**Concrete Beam Receiver Base (Upper & Lower Plate) 6173-1**  
Two-piece system bolts to concrete beams and provides a receiver for system end and midpoint stanchions



**Rebar & Nelson Stud Tieback Bracket 6202-1**  
Tieback bracket for Nelson Studs between 3/4" and 1-1/4" and rebar between #6 and #11



**Nelson Stud Receiver Base 6260-1**  
Clamps directly to Nelson studs

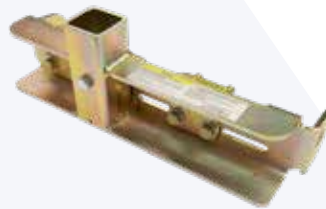

**Modular Stanchion Receiver Base 6262-1**  
Attaches to Nelson Studs with a diameter of 3/4" to 1-1/4" & rebar sizes #6 to #11



**Cable Tieback Assembly 1/2", Adjustable 21' Length 6077-XX**  
Galvanized Cable



**Adjustable StrongBack™ 6141-1**  
Also available:  
Standard Length Narrow/Wide - 6140 (83.5")  
Standard Length Narrow/Narrow - 6142 (82")  
Wide - 6131 (99.5")  
Narrow - 6132 (99.5") \*Products differ in anchor & stanchion compatibility

*StrongBack™ installation allows for horizontal lifeline installation when the use of tie back cables is not possible. StrongBacks can also be utilized with weld on receivers, and allow greater flexibility for leading edge access.*



# SKYLINE™ FREE-STANDING HORIZONTAL LIFELINES

## Rebar Anchorage Bases | Specialty Bases

Reliance's Commercial Rebar Systems are designed to be installed on columns, piers or beams where rebar has been left stubbed up or protruding from the structure. Exposed rebar may also be used to connect a Horizontal Lifeline System to a structure while installing or removing forms. Utilizing rebar-specific anchors and tie back anchor plates, system installation is simple and flexible. With our large selection of off the shelf components, almost any structure may be fitted with a permanent or temporary Reliance horizontal lifeline. With the ability to "tune" our lifeline systems, Reliance can accommodate clearance and span geometries that our competitors have difficulty with.



**Rebar Anchor Assembly 6203-1**

For rebar sizes #6 to #11



**Rebar Tieback Anchor Plate 6200-1**

For rebar sizes #6 to #11. Part #'s vary by size



**Rebar Anchor Assembly 3088-1**

For rebar sizes #6 to #11. Part #'s vary by size



**PVC Drop-In Sleeve for Stanchion 6181-1**

Cast in place in concrete and provides a receiver for end & midpoint stanchions



**Adjustable Tieback Cable 6077-XX**

1/2" - 6X19 (XX denotes length)

Used to tension & support end stanchions



**Rebar Anchor Stanchion Head Assembly 6210-21**

6200-21: Gold for 60" Stanchion

6210-21: Gold for 72" Stanchion

6220-21: Gold for 84" Stanchion

**Rebar Anchor Lug Plate for Concrete Construction 3083-12**

8" X 8" single lug bolt-down anchor plate for tie back in concrete

3084-1: Bypass Plate

6185-10: End Stanchion Receiver Plate

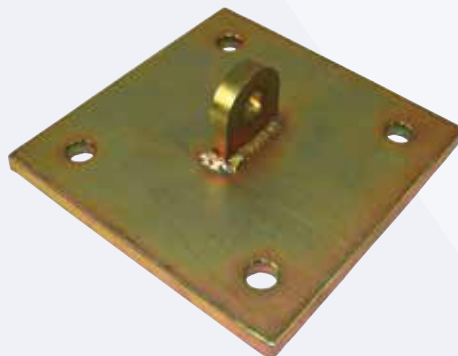

**60", 72", 84" Concrete Rebar Stanchions**

**6200-23, 6210-23, 6220-23**

Commercial Rebar Stanchion Tube, 60", 72", 84".

6200-23 : Gold color - 60"

6210-23 : Silver Color - 72"

6220-23 : Black Color - 84"



# SKYLINE™ PERMANENT HORIZONTAL LIFELINE

Skyline Permanent Horizontal Lifelines are ideal for environments where a permanent form of fall protection anchorage is consistently required. Systems are typically installed overhead, and provide users with the mobility necessary to perform their job. These systems utilize the 6300 Horizontal Lifeline, which contains no textile elements, and is designed to withstand the harshest of environments. End anchors are designed for permanent installation, and custom anchors can be designed to accommodate specific instances as required.

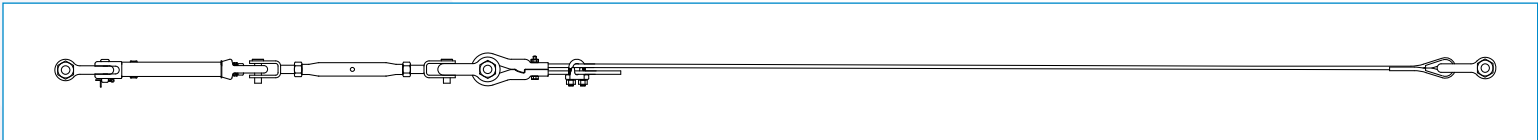

## 6300 System Components



Bow Shackles (2 ea) 6062-1



In Line Energy Absorber 6000-1



Rigging Screw 6021-1



Bow Shackle (1 ea) 6066 - 1



3/8" Wire Rope Combo Clamp 6055-1



3/8" Wire Rope Clip 6082-1



Cable 6070-XX Standard lengths available

## Structural Anchorage Systems for use with Permanent Systems



### Weld-On Anchorage Lugs 6XXX

- 6158 - Single Hole Galvanized
- 6160 - Single Hole Stainless
- 6161 - Double Hole Galvanized
- 6162 - Double Hole Stainless



### Weld-On Receiver 6154-1

This is an economical alternative to beam clamps



### Weld-On Bypass Bracket 6167-1

This is an economical alternative to additional stanchions with pass-thrus

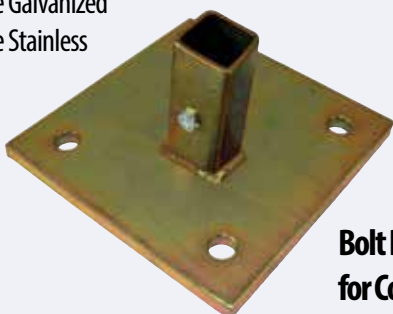

Bolt Down Stanchion Receiver for Concrete 6185-10

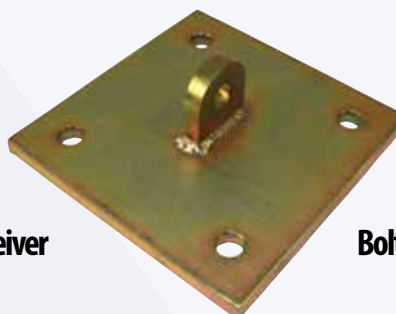

Bolt -In Anchor Plate 3080-12

# ALUMINUM RAIL FALL ARREST SYSTEM

Falls from elevated work locations are a leading cause of injuries and fatalities in the workplace each year. When fall hazards exist over an expanse, they can be a challenge to mitigate. Horizontal Lifeline Systems are commonly used to protect workers in these scenarios in order to provide continuous protection as they traverse the area adjacent to the hazard.

Why choose a Rigid Rail System instead? In many cases, Horizontal Lifeline Systems may not be effective. They often require more clearance than is available, and they always require substantial structural anchorages to support the end-loads. The Aluminum Rail Fall Arrest System does not substantially deflect under dynamic fall arrest loading, so the required clearances are considerably reduced. Additionally, due to the strength and rigidity of the rail segments, the dynamic loads that are transmitted to the structural anchorages are considerably less severe. When used in conjunction with our SkyLoc™ II SRLs, arrest distances are less than 24”.

Rigid Rail Systems are nothing new. Traditionally they been constructed of steel, and the ‘track’ which contains the traversable trolley requires a complicated truss system to support it and give it strength. The Aluminum Rail Fall Arrest System was designed to simplify this solution to make it more affordable and to reduce the cost and complication involved with the installation of these types of systems.

## ARFAS Components

### Minimal Components, Maximum Protection.

#### The Rail

Extruded from a rugged, durable aluminum alloy, the standard 5 meter (16’) rail segment requires no intermediate support, and can cantilever up to 5’.

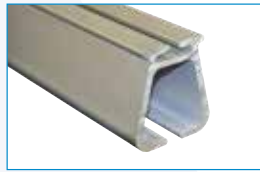

#### The Splice

Extruded from the same dependable alloy, the splice simply slides over the top of two adjacent segments and joins them together by through the tightening of 8 simple fasteners.



#### The Hangers

Constructed from the same material as The Rail and The Splice, The Hangers are installed on top of the rail segment at or adjacent to each end at each splice location. All that is required is a simple twist of the wrist and the tightening of two set screws.



#### The Adapter Brackets

Connects the ARFAS to the overhead structure at each required hanger location. Available in a variety of configurations to accommodate a wide array of structures.

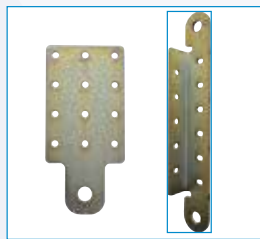

#### The Trolley

Forged from Stainless Steel and featuring UHMW wheels and sealed bearings. The oblique orientation of the wheels allows the trolley to run true, even when travelling parallel to, but directly beneath the rail.



## Advantages

### Aluminum Rigid Rail System

- Overhead anchorages coupled with the Reliance SkyLoc™ II SRL means arrest distances less than 24”
- Requires less clearance and structural strength than HLL systems
- Ideal for permanent installation indoors or out in virtually any environment
- Allows safe access over a broad area adjacent to fall hazards
- Easily adapted to virtually any building or overhead structure

# Mounting Options

The simplicity of the ARFAS componentry translates to a wider variety of mounting options, and a much more versatile method of mitigating fall protection challenges. Multiple rail systems can be connected to provide a high degree of fall protection coverage.

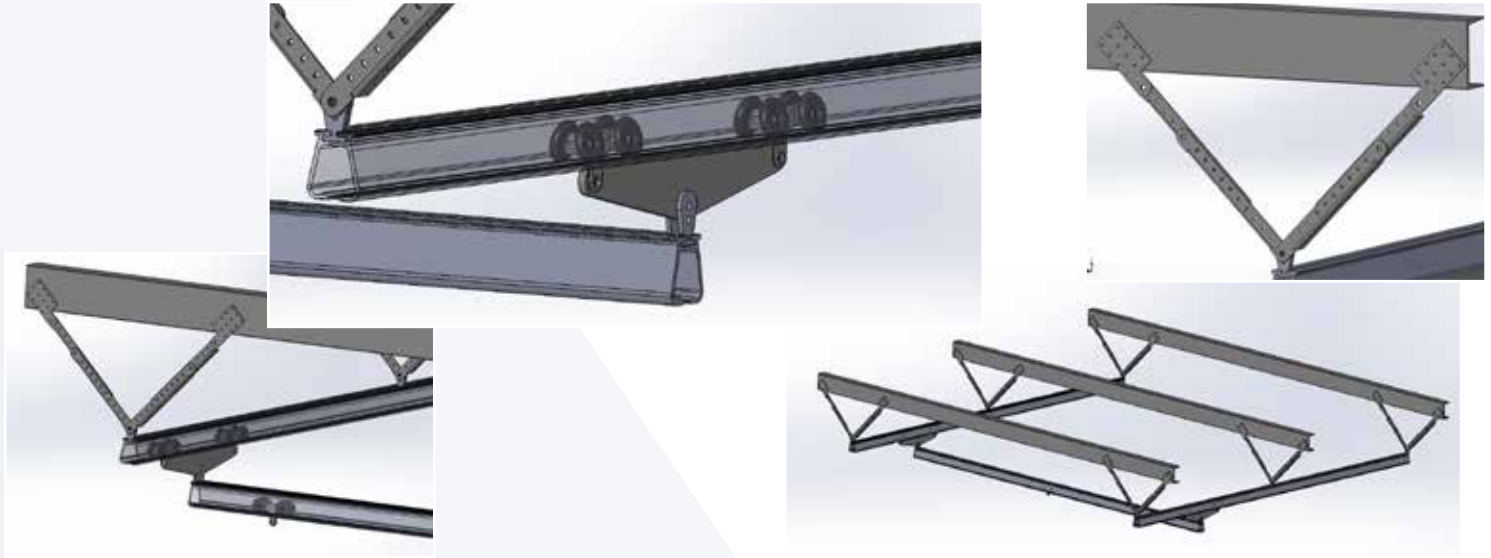

## ARFAS Components

Minimal Components, Maximum Protection.

### Reliance Aluminum Rail Fall Arrest System Components

Part Number	Description
1700100-1	5 Meter Rail Segment, Standard
1700101-1	Raill Segment, Standard, per Foot
1730100-1	Rigid Rail Trolley, Standard, Stainless
1710200-1	Rail Splice, Standard Segment
1710100-1	Rail Hanger, Standard 4-Pack
1710101-1	Hanger, Parallel Purlin Bracket
1710102-1	Hanger, I-Beam Clamp
1710103-1	Hanger, Purlin Mounting Plate
1710104-1	Hanger, Bar Joist
1710112-1	Arm, Rail Hanger, 12"
1710124-1	Arm, Rail Hanger, 24"
1710136-1	Arm, Rail Hanger, 36"
1710113-1	Hardware Kit, Fixed Hanger Arm
1710114-1	Hardware Kit, Adjust Hanger Arm

# LADDER STANCHION SYSTEM

Ladder falls are routinely the 2nd leading cause of fatalities in industry. When the results don't end in a fatality, they are more often serious disabling type injuries. As of November 2016, OSHA has turned their focus to this known hazard by providing new regulations for fall protection ladder safety. Ladder cages are a solution of the past, and the requirement for fixed ladder safety systems is the new normal. This new normal will mean big changes over the next 20 years for industry facilities, worker safety, and the training required ensuring this standard is a success.

Since 2010 Reliance has advocated these changes be met with sensible ready-made solutions. The first launch of the Vertical Ladder Stanchion (Part # 6512) proved successful for contractors in plant facilities by creating an overhead anchorage used with our high performing Self-Retracting Lanyards. The new and improved Vertical Ladder Stanchion (Part # 6514/6515) features greater adjustability, and taller anchor heights that keep your Self-Retracting Lanyard overhead even with step-thru style ladders. This makes the Vertical Ladder Stanchion System the optimum solution for fixed ladder safety moving forward.



## SYSTEM COMPONENTS

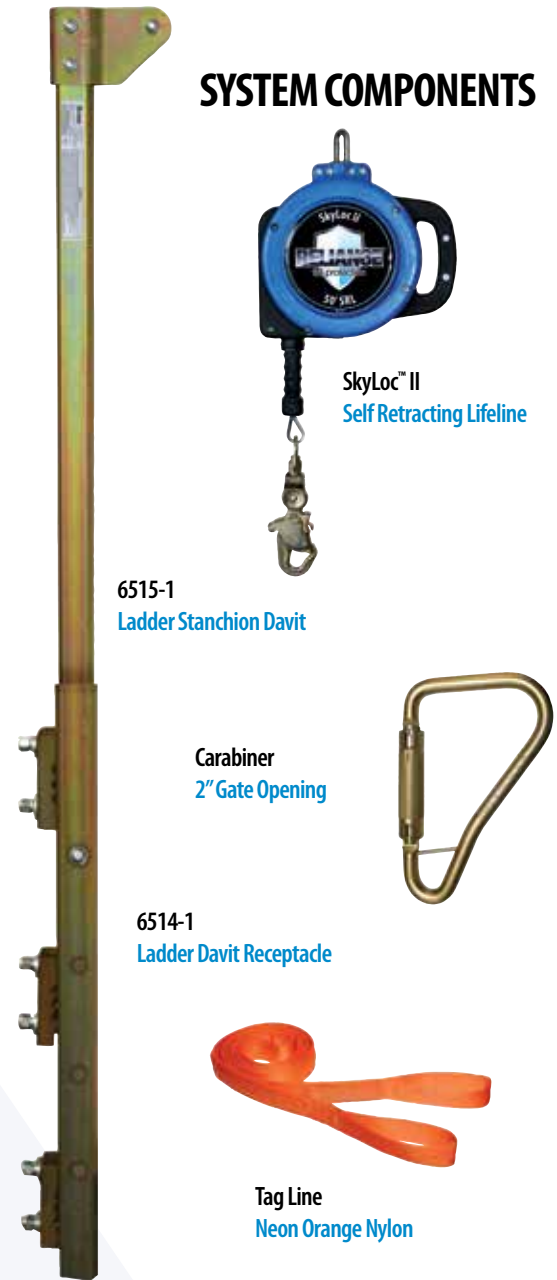

6515-1  
Ladder Stanchion Davit

SkyLoc™ II  
Self Retracting Lifeline

Carabiner  
2" Gate Opening

6514-1  
Ladder Davit Receptacle

Tag Line  
Neon Orange Nylon

### Reliance Vertical Stanchion System & Components

Part Number	Description
6514-1	Receptacle Ladder Davit Adjustable
6515-1	Vertical Ladder Stanchion Davit
6520-1	Vertical Ladder Stanchion and Receiver System (Includes 6514-1 and 6515-1)
6520-30	Vertical Ladder Stanchion System, 30' Includes: Ladder Stanchion, Stanchion Receiver, SkyLoc™ II 30', Large Carabiner, and 30' Tag Line
6520-50	Vertical Ladder Stanchion System, 50' Includes: Ladder Stanchion, Stanchion Receiver, SkyLoc™ II 50', Large Carabiner, and 50' Tag Line
6520-100	Vertical Ladder Stanchion System, 100' Includes: Ladder Stanchion, Stanchion Receiver, SkyLoc™ II 100', Large Carabiner, and 100' Tag Line

# ROPE GRABS

## Rope Grabs 5000/5001

Automatic fall-arrestors locks itself immediately on the vertical lifeline in the event of a fall. "Hands Free" operation on weighted vertical safety line. Moves freely along 5/8" (16mm) rope on brass rollers. 5000: Hinge Opening, 5001 Feed-Thru.

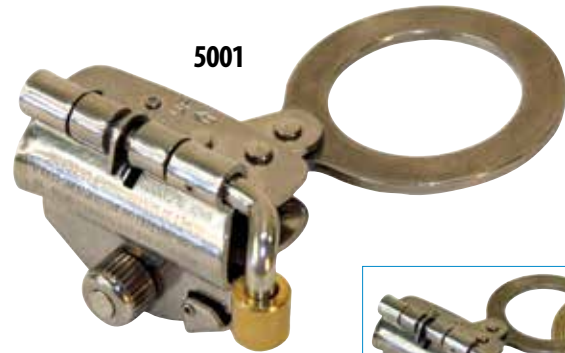

5001



Easily accommodates snaphook connection



5000



5000 & 5001 with attached 732101 shock absorbing lanyards

## Vertical Rope Lifelines 5010-XXX Series

The 5010-XXX Series of Vertical lifelines are made from a combination fiber rope with a firm lay, excellent wear and a high strength to weight ratio. Produced with high strength continuous filament polyester surface yarns wrapped over high tenacity Ultra Blue™ Fiber. Comes with 1 spliced eye with a thimble and 3062-36 carabiner.

- 5010-25 Vertical lifeline 25' w/ carabiner
- 5010-50 Vertical lifeline 50' w/ carabiner
- 5010-100 Vertical lifeline 100' w/ carabiner
- 5010-150 Vertical lifeline 150' w/ carabiner
- 5010-200 Vertical lifeline 200' w/ carabiner
- 5010-250 Vertical lifeline 250' w/ carabiner
- 5010-300 Vertical lifeline 300' w/ carabiner
- 5010-1 Vertical lifeline 600' w/ carabiner



Vertical Lifeline Fall Arrestor's should only be used with shock absorbing lanyards 3' (.9m) in length or less. Lanyards greater than 3' may produce free falls greater than 6' (1.8m) and produce a MAF greater than 1,800 lbs. (8kN) We recommend a Reliance 731103 shock absorbing lanyard.

# FALL PROTECTION PRODUCT CATALOG



# HIGHER STANDARDS IN PERSONAL FALL PROTECTION